

# Architectural Product Guide

Pergotende® Impact | Miami Awning, Miami FL

THE  
outdoor  
ALCHEMIST

**Corradi**  
OUTDOOR LIVING SPACE

Time to...

**live**

**Outdoors**

THE  
outdoor  
ALCHEMIST  
—  
[corradiusa.com](http://corradiusa.com)

**Corradi**  
OUTDOOR LIVING SPACE

index



- 2.** What we give to you
- 4.** 8 good reasons to choose Corradi
- 6.** Pergotenda®
  - 11. Impact
  - 19. Palladia®
  - 29. B-Space
  - 39. Kubo
  - 43. Millenium®
  - 49. 45/60
  - 55. 100
  - 59. Arko
- 72.** Louvered Roof
  - 77. Alba
- 88.** Exterior Screens
  - 93. Summit
  - 99. Harbor
  - 105. Vista
  - 109. Horizon
- 116.** Shading
  - 121. Shan
  - 129. Svet
  - 133. Klip & Klip Pod
  - 137. Feng
  - 143. Frame
  - 147. Defense
- 152.** Fabrics
- 160.** Motorization
- 168.** Why Corradi?
- 170.** Disclaimer
- 172.** Credits

# We give space to your time.

## Time for your design

Find your outdoor muse. Every project begins with inspiration, bringing thought to life in the measure of blueprints and themes. Alchemy starts where the style and continuity you envision is translated into the reality of technical drawings and certified engineering. Corradi offers unequivocal excellence in unique solutions help you realize your outdoor possibilities. Your ideas become the essence of many conversations and collaborations to create an ideal outdoor space built by the alchemists that will carry your vision through to the finish line.

**Our ingenuity fuels your creativity.**

## Time for your business

The outdoor spaces of restaurants, hotel poolside or wellness spaces, suite terraces, urban pedestrian areas all have great potential. With Corradi's outdoor solutions they can be used for many more months of the year. Since 1978 Corradi has offered contract market customized solutions to bring to life the utmost potential of outdoor spaces. Take advantage of your outdoor space to increase your business and enjoy it in every season.

**Our experience guarantees your success.**

## Time for you

Time. Time to do things or to do nothing. Time to think. Time to free your mind. Time to live, alone or with others. Like an alchemist, Corradi draws out the original energy from every outdoor area, transforming it into a living space personalized just for you.

**We give space to your time to give you space for your life.**



1

Increase the total capacity of your activity.

2

Take advantage of Corradi's support.

8

good reasons to  
choose Corradi

Take advantage of Corradi's technical resources and sampling to assist in your design.

5

Put your trust in a partner with over 40 years of experience.

6



3

Give an exclusive design to your outdoor space experience.

4

Improve and customize spaces otherwise underestimated.



Pergotenda® Kubo  
Outdoor Living Solutions, London ON Canada

Protect your patrons from extreme temperatures, rain and other unpleasant weather conditions.

Increase your turnover and repeat customers thanks to a tailored solution for your outdoor space.

7

# Pergotenda®



Pergotenda® is the sliding covering system patented by Corradi, made-to-measure and customizable to make outdoor spaces comfortable and enjoyable for many months out of the year.



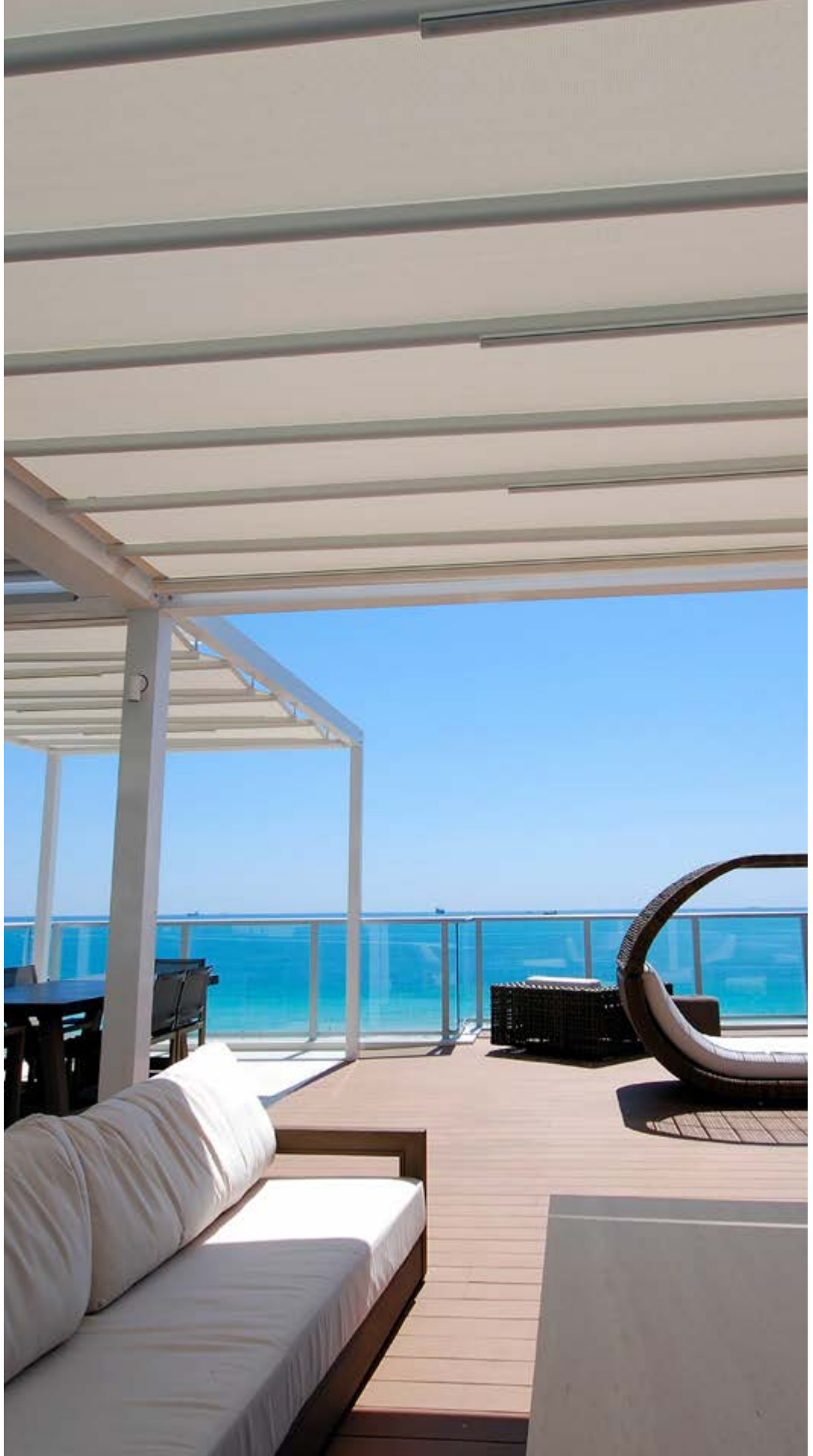

Pergotenda® Impact | Miami Awning, Miami FL

# Pergotenda®

Claim your outdoor space with ease of control and exceptional performance in weather protection.

Experience the unique comfort that only Corradi Pergotenda® retractable roof systems create.

Many different Pergotenda® retractable shading systems are available to answer countless outdoor design needs. With aluminum and wood frames offered in a spectrum of frame colors, beautiful fabric styles, smooth motorization control and unique customization options to adapt your outdoor space—the possibilities are truly endless. Pergotenda® can maximize the use of your restaurant patio or expand the luxury of your own backyard. Take a look through our collection of various styles, features, and options to find out which product offers the answer to the perfect outdoor space you are looking for.

Items listed may vary from model to model but they are all representative of Corradi technology.



GABLE



ECLISSI FABRIC



STRATUS DROP SCREEN



SOMFY® MAESTRIA  
DROP SCREEN MOTOR  
*with obstacle  
detection options*



SHYZIP SPRING TRACKS

PATENT



MOBILE GUTTER JUNCTION



LIGHTS

SCREWS AND COMPONENTS IN STAINLESS STEEL

PATENT



SINGLE CANVAS WIDTH UP TO 512 INCHES

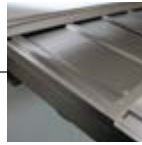

STANDARD PROTECTION COVER

PATENT



CANVAS STRETCHING (ENGINE 2/3)

PATENT



6 WHEELS SLIDER

PATENT



ANTIDROP SYSTEM

PATENT



IMPACT®

PATENT



RETRACTABLE GUTTER

somfy possibilities

RTS (RADIO TECHNOLOGY SOMFY®) CONTROL.

- CONTROLS
- SENSORS
- TIMERS
- AUTOMATION CONNECTIVITY
- AND MORE...



See page 162 for more information...



# Pergotenda® Impact



Pergotenda® Impact | New Haven Awning, New Haven CT

The Impact is the “heart” of every Pergotenda® system. The core retractable cover system, made to size for the protection from sun and rain, that can be installed on suitable pre-existing structures.

Time to create with alchemy



Installed on all Corradi structures, Impact can also be used with pre-existing pergolas or other structures.

Pergotenda® Impact | We Got You Covered Outdoor, Mooresville NC







Slack canvas.

Pergotenda® Impact | Made in the Shade Inc., Las Vegas NV



Taught canvas.



Taught canvas with spacers.

Pergotenda® Impact | Miami Awning, Miami FL



Trapezoidal canvas.



Pergotenda® Impact | Miami Awning, Miami FL



# PERGOTENDA® IMPACT



**Impact** is an aluminum structure with a retractable folding canvas. The fabric is supported by intermediate supporting tubes (1.6"x2") and terminal bars (3.2"x2") set parallel to one another every 24" approximately on pitched version and every 20" approximately on flat version. The Impact system is set in motion by a radio-controlled Dunker D839 motor with a Somfy® brand receiver. The canvas moves by sliding on the runners (2"x3.5") on carriers with 6 asymmetrical wheels with a capacity of about 1000 lbs. each. The toothed transmission belt has stainless steel cables and resists high salinity environments. The tensile strength is of 2000 lbs at break. The transmission belt is inserted in each runner, controlled by the drive pulley and a single drive shaft that guarantees the smooth movement of the canvas. Hardware and accessories are 304 stainless steel. While Corradi USA possesses a great deal of data related to engineering for the Pergotenda® product line that is related to wind ratings and load data that has been developed through specific product tests, case studies and IBC testing. It is understood that when required and due to the custom nature of our projects, engineering must be project specific and adhere to the rules and regulations at the local level where such a project shall be planned and installed.

## FEATURES

**ANTIDRIP SYSTEM** Weldable PVC profile on the upper part of the canvas for lateral rainwater retention. This PVC profile is welded to each far side of a pitched roof canopy to prevent water from dripping over the sides and forces the water to shed into the gutter system.

**ANTISPRAY PROFILE** PVC profile inserted on the lateral side of the runner for retention of rainwater spray. Always in addition to the ANTIDRIP SYSTEM. The AntiSpray prevents water from a heavy downpour from "splashing" over the AntiDrip profile and dripping over the sides.

**INTEGRATION** The Impact is very unique in that it can be installed into pre-existing and custom designed frames.

**MOTOR BEAM** Aluminum profile and corresponding accessories to be fixed to self-supporting motor or, in addition, to support the protective cover.

**MOTORIZATION** All Pergotenda® are motorized, giving you complete control at the touch of a button.

## OPTIONS

**ADD-ON INTERMEDIATE SUPPORT TUBE** Used to reduce the height of the canopy swag when the roof unit is retracted, usually for purposes of clearing a door opening or a window. Only two (2) tubes total may be added to any single roof canopy.

**ADD-ON RUNNER** The mechanical Runner is the equivalent of roof truss or rafter and is what the roof canopy is attached to. Adding a Runner is considered when the roof pitch angle needs to be reduced to properly shed water and manage it into the gutter systems. Adding a runner may also be considered to reduce the pitch of the roof for design purposes as well.

**FAUX CEILING** A unique option that hangs a colorful fabric beneath the roofing material to add warmth and atmosphere to the room. The Faux Ceiling fabric can provide for an excellent opportunity to blend other colors or materials that are part of furnishings or cushions. The softer fabric material may also be a benefit in reducing noise or providing other minimal acoustic properties to dampen surrounding noise. This option will depend on the type of fabric. The Faux Ceiling fabric generally must be from the Corradi USA collection or an approved alternate.

**HOOD** The Protective Hood Cover is an aluminum corrugated standing seam cover that is positioned where the unit mounts to the wall or at the back of the unit on a Freestanding model for the purpose of protecting the Roof Canopy Swags that are created when the roof retracts and to prevent any water or debris from collecting in the swags. The Protective Hood Cover is powder coated for longevity.

**LIGHTING** The Pergotenda® lighting system is a custom designed system that seamlessly integrates into the Pergotenda® intermediate tubes.

**PITCHED OR FLAT** Both pitched (angled) roof and flat roof options are available for the Impact.

**RETRACTABLE GUTTER** Extruded aluminum profile for rainwater collection, only for pitched versions, fixed to the end support tube. One drainage per runner. Down pipes not provided. The gutters moves with the roof canopy and has downspouts that merge into a CNC cut in each front supporting post.

**TRAPEZOIDAL FABRIC (flat versions only)** An alternative drainage option for flat systems to let you control which side of the system you want rain to fall off.

**UNDERSIDE DRIP-COLLECTION RIM (flat versions only)** Welded PVC profile on the underside of the roof canopy to channel water into the side gutters and to prevent water from running along the underside of the roof canopy and dripping down.

## FRAME COLORS

### POWDER COATING\*

The aluminum extrusions are painted with certified Qualicoat cycle epoxy powders. The support tubes come in: White Quartz, Glacier, & Beach Sand to match with the Eclissi fabric.



WHITE QUARTZ



ANTHRACITE



CARBON



GLACIER



BEACH SAND



DUNE



GRANITE



CORTEN



URBAN BRONZE

\*RAL CUSTOM COLOR POWDER COATING IS ALSO AVAILABLE

Due to print variation these finish images should not be used for final production specifications.

## FABRICS

### ECLISSI BLACKOUT FABRIC

Eclissi fabric is exclusively used by Corradi USA for Pergotenda® structures. It is a High tenacity 1100 Dtex Polyester base fabric with PVC laminate. The embossed finish on the inner side gives a textile appearance and a dynamic welt effect on the viewable surface. The outer side has an anti-dust acrylic lacquer. This unique 4-ply material has a blackout layer that also acts as a radiant barrier, providing superior heat resistance and heat gain as compared to other textiles used in these types of applications. It is available in 3 colors:



ECLISSI WHITE



ECLISSI GREY



ECLISSI IVORY

### OTHER RETRACTABLE ROOF FABRICS AVAILABLE

#### SERGE FERRARI SOLTIS PROOF W96

See Fabrics section pg. 155 for more information on this fabric.

#### SERGE FERRARI SOLTIS PROOF 502

See Fabrics section pg. 155 for more information on this fabric.

#### SERGE FERRARI SOLTIS PERFORM 92

See Fabrics section pg. 155 for more information on this fabric.

#### SERGE FERRARI SOLTIS HORIZON 86

See Fabrics section pg. 155 for more information on this fabric.

## MOTORS

### RADIO CONTROLLED DUNKER D839

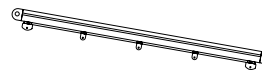

#### PITCHED MAX DIMENSIONS

	Width	Projection
2 runner	197"	354"
3 runner	354"	354"
4 runner	512"	354"
5 runner*	512"	354"

#### FLAT MAX DIMENSIONS

	Width	Projection
2 runner	197"	354"
3 runner	315"	354"
4 runner	472"	354"

\*5 runner available pitched only

Note: when pitched and has 4 to 5 runners, system will require 2 motors.







# Pergotenda® Palladia®



With a wide range of sizes and multiple options, the wall-mounted Palladia® is our most popular classic aluminum Pergotenda® with the ability to match any outdoor living style.

Time to draw "en plein air"

Made of aluminum and stainless steel, Palladia® is a wall-mounted Pergotenda® with a well-defined and essential design.

When open around the perimeter, its structure emphasizes the lines of the front nodes, whereas using Stratus Screens, Palladia® reveals an entirely new, captivating and innovative character.

### Design of character









Pergotenda® Palladia® with Stratus ShyZip® Screens | Miami Awning, Miami, FL

**Giving you space**



Providing beautiful views



Pergotenda® Palladia® | New Haven Awning, New Haven CT



Pergotenda® Palladia® with Clear Vinyl Stratus ShyZip® Screens  
New Haven Awning, New Haven CT

# PERGOTENDA® PALLADIA® WALL TO WALL

Palladia® Wall to Wall Pergotenda® is a solution for installations that require a Pergotenda® system and frame that attaches to a wall or structure at each end. It uses

special brackets to attach to the walls or ceiling on each side for support. It has most of the same attributes as a traditional Palladia® Pergotenda®, but without pillars or corner pieces.



## FEATURES

**ANTIDRIP SYSTEM** (pitched versions only) Weldable PVC profile on the upper part of the canvas for lateral rainwater retention. This PVC profile is welded to each far side of a pitched roof canopy to prevent water from dripping over the sides and forces the water to shed into the gutter system.

**ANTISPRAY PROFILE** (pitched versions only) PVC profile inserted on the lateral side of the runner for retention of rainwater spray. Always in addition to the ANTIDRIP SYSTEM. The AntiSpray prevents water from a heavy downpour from “splashing” over the AntiDrip profile and dripping over the sides.

**UNDERSIDE DRIP-COLLECTION RIM** (flat versions only) Welded PVC profile on the underside of the roof canopy to channel water into the side gutters and to prevent water from running along the underside of the roof canopy and dripping down.

**MOTORIZATION** All Pergotenda® are motorized, giving you complete control at the touch of a button.

**HOOD** The Protective Hood Cover is an aluminum corrugated standing seam cover that is positioned where the unit mounts to the wall or at the back of the unit on a Freestanding model for the purpose of protecting the Roof Canopy Swags that are created when the roof retracts and to prevent any water or debris from collecting in the swags. The Protective Hood Cover is powder coated for longevity.

## OPTIONS

**ADD-ON INTERMEDIATE SUPPORT TUBE** Used to reduce the height of the canopy swag when the roof unit is retracted, usually for purposes of clearing a door opening or a window. Only two (2) tubes total may be added to any single roof canopy.

**ADD-ON RUNNER** The mechanical Runner is the equivalent of roof truss or rafter and is what the roof canopy is attached to. Adding a Runner is considered when the roof pitch angle needs to be reduced to properly shed water and manage it into the gutter systems. Adding a runner may also be considered to reduce the pitch of the roof for design purposes as well.

**FAUX CEILING** A unique option that hangs a colorful fabric beneath the roofing material to add warmth and atmosphere to the room. The Faux Ceiling fabric can provide for an excellent opportunity to blend other colors or materials that are part of furnishings or cushions. The softer fabric material may also be a benefit in reducing noise or providing other minimal acoustic properties to dampen surrounding noise. This option will depend on the type of fabric. The Faux Ceiling fabric generally must be from the Corradi USA collection or an approved alternate.

**WALL BEAM** Aluminium profile for uneven walls, where standard fastening to supports is awkward; or otherwise to deal with minor bumps.

**GABLE (pitched versions only)** A fixed fabric portion used to enclose the angled gap on both sides of a pitched system when using screens.

**LIGHTING** The Pergotenda® lighting system is a custom designed system that seamlessly integrates into the Pergotenda® intermediate tubes.

**PITCHED OR FLAT** Both pitched (angled) roof and flat roof options are available for the Impact.

**FIXED FRONT GUTTER (pitched versions only)** Extruded aluminium profile for rainwater collection. Down pipes (1 about every 236 in.) and accessories included.

**STRATUS SCREEN** An exterior screen specifically designed to integrate into most Pergotenda® systems for complete enclosure that assists in protection from the elements and gives the option of privacy.

**TRAPEZOIDAL FABRIC (flat versions only)** An alternative drainage option for flat systems to let you control which side of the system you want rain to fall off.

**WALL OR CEILING MOUNT** Available mounted to a wall or ceiling.

The Palladia® Wall to Wall offers the same frame, fabric and motor options as the standard Palladia® Pergotenda®.

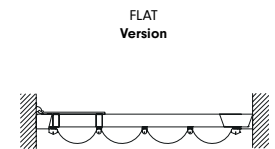
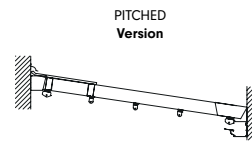

PITCHED MAX DIMENSIONS		
	Width	Projection
2 runner	197"	256"
3 runner	354"	256"
4 runner	512"	256"
5 runner*	512"	256"

FLAT MAX DIMENSIONS standard slack		
	Width	Projection
2 runner	138"	236"
3 runner	276"	236"
4 runner	413"	236"

\*available pitched only

When pitched and has 4 to 5 runners, system will require a type 3 motor—which consists of one control board and 2 motors.

FLAT MAX DIMENSIONS TRAPEZOIDAL slack		
	Width	Projection
2 runner	197"	256"
3 runner	315"	256"
4 runner	472"	256"

# PERGOTENDA® PALLADIA®



**Palladia®** is a retractable cover system mounted to a wall, custom made to protect against sun and rain. It consists of an aluminum structure and a folding canvas. The fabric is supported by intermediate supporting tubes (1.6"x2") and terminal bars (3.2"x2") set parallel to one another every 24" approximately on pitched version and every 20" approximately on flat version. It slides on runners with built-in splash-guard (2.4"x4.8") on carriers with 6 asymmetrical wheels with a capacity of about 1000 lbs each. The toothed transmission belt has stainless steel cables and resists a saline environment; the tensile strength is of 2000 lbs at break; the transmission belt is inserted in each runner, controlled by the drive pulley and a single drive shaft that guarantees the smooth movement of the canvas. The Palladia® system is operated by a radio-controlled Dunker D839 motor. Aluminum tubular structure is 2.4"x4.8". Hardware and accessories are 304 stainless steel. While Corradi USA possesses a great deal of data related to engineering for the Pergotenda® product line that is related to wind ratings and load data that has been developed through specific product tests, case studies and IBC testing. It is understood that when required and due to the custom nature of our projects, engineering must be project specific and adhere to the rules and regulations at the local level where such a project shall be planned and installed.

## FEATURES

**ANTIDRIP SYSTEM** Weldable PVC profile on the upper part of the canvas for lateral rainwater retention. This PVC profile is welded to each far side of a pitched roof canopy to prevent water from dripping over the sides and forces the water to shed into the gutter system.

**ANTISPRAY PROFILE** PVC profile inserted on the lateral side of the runner for retention of rainwater spray. Always in addition to the ANTIDRIP SYSTEM. The AntiSpray prevents water from a heavy downpour from "splashing" over the AntiDrip profile and dripping over the sides.

**MOTORIZATION** All Pergotenda® are motorized, giving you complete control at the touch of a button.

**HOOD** The Protective Hood Cover is an aluminum corrugated standing seam cover that is positioned where the unit mounts to the wall or at the back of the unit on a Freestanding model for the purpose of protecting the Roof Canopy Swags that created when the roof retracts and to prevent any water or debris from collecting in the swags. The Protective Hood Cover is powder coated for longevity.

## OPTIONS

**ADD-ON INTERMEDIATE SUPPORT TUBE** Used to reduce the height of the canopy swag when the roof unit is retracted, usually for purposes of clearing a door opening or a window. Only two (2) tubes total may be added to any single roof canopy.

**ADD-ON RUNNER** The mechanical Runner is the equivalent of roof truss or rafter and is what the roof canopy is attached to. Adding a Runner is considered when the roof pitch angle needs to be reduced to properly shed water and manage it into the gutter systems. Adding a runner may also be considered to reduce the pitch of the roof for design purposes as well.

**FAUX CEILING** A unique option that hangs a colorful fabric beneath the roofing material to add warmth and atmosphere to the room. The Faux Ceiling fabric can provide for an excellent opportunity to blend other colors or materials that are part of furnishings or cushions. The softer fabric material may also be a benefit in reducing noise or providing other minimal acoustic properties to dampen surrounding noise. This option will depend on the type of fabric. The Faux Ceiling fabric generally must be from the Corradi USA collection or an approved alternate.

**FRONT BEAM** Finishing aluminum profile for the closing application. Required in order to strengthen the structure with a projection over 157", but not necessary if front screens (Stratus) are applied.

**GABLE (pitched versions only)** A fixed fabric portion used to enclose the angled gap on both sides of a pitched system when using screens.

**LIGHTING** The Pergotenda® lighting system is a custom designed system that seamlessly integrates into the Pergotenda® intermediate tubes.

**PITCHED OR FLAT** Both pitched (angled) roof and flat roof options are available for the Impact.

**RETRACTABLE GUTTER** Extruded aluminum profile for rainwater collection, only for pitched versions, fixed to the end support tube. One drainage per runner. Down pipes not provided. The gutters moves with the roof canopy and has downspouts that merge into a CNC cut in each front supporting post.

**STRATUS SCREEN** An exterior screen specifically designed to integrate into most Pergotenda® systems for complete enclosure that assists in protection from the elements and gives the option of privacy.

**TRAPEZOIDAL FABRIC (flat versions only)** An alternative drainage option for flat systems to let you control which side of the system you want rain to fall off.

**UNDERSIDE DRIP-COLLECTION RIM (flat versions only)** Welded PVC profile on the underside of the roof canopy to channel water into the side gutters and to prevent water from running along the underside of the roof canopy and dripping down.

**WALL OR CEILING MOUNT** Available mounted to a wall or ceiling.

## FRAME COLORS

### POWDER COATING\*

The aluminum extrusions are painted with certified Qualicoat cycle epoxy powders. The support tubes come in: White Quartz, Glacier, & Beach Sand to match with the Eclissi fabric.



WHITE QUARTZ



ANTHRACITE



CARBON



GLACIER



BEACH SAND



DUNE



GRANITE



CORTEN



URBAN BRONZE

\*RAL CUSTOM COLOR POWDER COATING IS ALSO AVAILABLE

Due to print variation these finish images should not be used for final production specifications.

## FABRICS

### ECLISSI BLACKOUT FABRIC

Eclissi fabric is exclusively used by Corradi USA for Pergotenda® structures. It is a High tenacity 1100 Dtex Polyester base fabric with PVC laminate. The embossed finish on the inner side gives a textile appearance and a dynamic welt effect on the viewable surface. The outer side has an anti-dust acrylic lacquer. This unique 4-ply material has a blackout layer that also acts as a radiant barrier, providing superior heat resistance and heat gain as compared to other textiles used in these types of applications. It is available in 3 colors:



ECLISSI WHITE

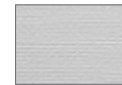

ECLISSI GREY



ECLISSI IVORY

### OTHER RETRACTABLE ROOF FABRICS AVAILABLE

#### SERGE FERRARI SOLTIS PROOF W96

See Fabrics section pg. 155 for more information on this fabric.

#### SERGE FERRARI SOLTIS PROOF 502

See Fabrics section pg. 155 for more information on this fabric.

#### SERGE FERRARI SOLTIS PERFORM 92

See Fabrics section pg. 155 for more information on this fabric.

#### SERGE FERRARI SOLTIS HORIZON 86

See Fabrics section pg. 155 for more information on this fabric.

## MOTORS

### RADIO CONTROLLED DUNKER D839

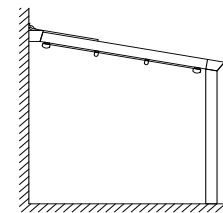

PITCHED MAX DIMENSIONS

	Width	Projection
2 runner	197"	256"
3 runner	354"	256"
4 runner	512"	256"
5 runner*	512"	256"

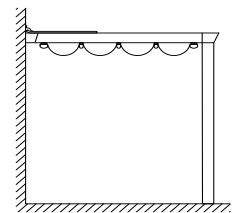

FLAT MAX DIMENSIONS

	Width	Projection
2 runner	138"	236"
3 runner	276"	236"
4 runner	413"	236"

FLAT MAX DIMENSIONS  
TRAPEZOIDAL slack

	Width	Projection
2 runner	197"	256"
3 runner	315"	256"
4 runner	472"	256"

\*5 runner available pitched only

Note: when pitched and has 4 to 5 runners, system will require 2 motors.











# Pergotenda® B-Space



The largest aluminum Pergotenda® system available. B-Space has all the functionality and features of any wall mounted aluminum Pergotenda®, but on a much grander scale.

Time to explore nature



Pergotenda® B-Space Wall-to-wall with custom frame | Miami Awning, Miami FL

**More space to offer**

Made of aluminum and anchored to a supporting wall, the B-Space is a Pergotenda® designed to cover large surfaces, with a projection of up to 29.5'. This makes the structure ideal for the commercial market.



**More space to enjoy**

Pergotenda® B-Space Wall-to-wall with custom frame | Miami Awning, Miami FL





Pergotenda® B-Space | Miami Awning, Miami FL





More space to live outdoors



Pergotenda® B-Space | Charlotte Tent & Awning, Charlotte NC

# PERGOTENDA® B-SPACE WALL TO WALL

B-Space Wall to Wall Pergotenda® is a solution for installations that require a Pergotenda® system and frame that attaches to a wall or structure at each end, just like the Palladia® Wall to Wall but on a larger

scale. It uses special brackets to attach to the walls or ceiling on each side for support. It has most of the same attributes as a traditional B-Space Pergotenda®, but without pillars or corner pieces.



## FEATURES

**ANTIDRIP SYSTEM** (pitched versions only) Weldable PVC profile on the upper part of the canvas for lateral rainwater retention. This PVC profile is welded to each far side of a pitched roof canopy to prevent water from dripping over the sides and forces the water to shed into the gutter system.

**ANTISPRAY PROFILE** (pitched versions only) PVC profile inserted on the lateral side of the runner for retention of rainwater spray. Always in addition to the ANTIDRIP SYSTEM. The AntiSpray prevents water from a heavy downpour from “splashing” over the AntiDrip profile and dripping over the sides.

**UNDERSIDE DRIP-COLLECTION RIM** (flat versions only) Welded PVC profile on the underside of the roof canopy to channel water into the side gutters and to prevent water from running along the underside of the roof canopy and dripping down.

**MOTORIZATION** All Pergotenda® are motorized, giving you complete control at the touch of a button.

**HOOD** The Protective Hood Cover is an aluminum corrugated standing seam cover that is positioned where the unit mounts to the wall or at the back of the unit on a Freestanding model for the purpose of protecting the Roof Canopy Swags that are created when the roof retracts and to prevent any water or debris from collecting in the swags. The Protective Hood Cover is powder coated for longevity.

## OPTIONS

**ADD-ON INTERMEDIATE SUPPORT TUBE** Used to reduce the height of the canopy swag when the roof unit is retracted, usually for purposes of clearing a door opening or a window. Only two (2) tubes total may be added to any single roof canopy.

**ADD-ON RUNNER** The mechanical Runner is the equivalent of roof truss or rafter and is what the roof canopy is attached to. Adding a Runner is considered when the roof pitch angle needs to be reduced to properly shed water and manage it into the gutter systems. Adding a runner may also be considered to reduce the pitch of the roof for design purposes as well.

**FAUX CEILING** A unique option that hangs a colorful fabric beneath the roofing material to add warmth and atmosphere to the room. The Faux Ceiling fabric can provide for an excellent opportunity to blend other colors or materials that are part of furnishings or cushions. The softer fabric material may also be a benefit in reducing noise or providing other minimal acoustic properties to dampen surrounding noise. This option will depend on the type of fabric. The Faux Ceiling fabric generally must be from the Corradi USA collection or an approved alternate.

**WALL BEAM** Aluminium profile for uneven walls, where standard fastening to supports is awkward; or otherwise to deal with minor bumps.

**GABLE (pitched versions only)** A fixed fabric portion used to enclose the angled gap on both sides of a pitched system when using screens.

**LIGHTING** The Pergotenda® lighting system is a custom designed system that seamlessly integrates into the Pergotenda® intermediate tubes.

**PITCHED OR FLAT** Both pitched (angled) roof and flat roof options are available for the Impact.

**FIXED FRONT GUTTER** Extruded aluminium profile for rainwater collection. Down pipes (1 about every 236 in.) and accessories included.

**STATUS SCREEN** An exterior screen specifically designed to integrate into most Pergotenda® systems for complete enclosure that assists in protection from the elements and gives the option of privacy.

**TRAPEZOIDAL FABRIC (flat versions only)** An alternative drainage option for flat systems to let you control which side of the system you want rain to fall off.

**WALL OR CEILING MOUNT** Available mounted to a wall or ceiling.

The B-Space Wall to Wall offers the same frame, fabric and motor options as the standard B-Space Pergotenda®.

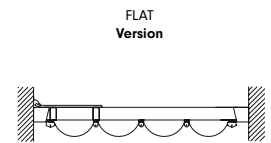
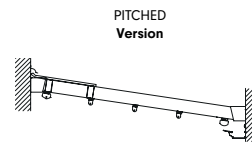

PITCHED MAX DIMENSIONS		
	Width	Projection
2 runner	197"	354"
3 runner	354"	354"
4 runner	512"	354"
5 runner*	512"	354"

FLAT MAX DIMENSIONS standard slack		
	Width	Projection
2 runner	138"	354"
3 runner	276"	354"
4 runner	413"	354"

\*available pitched only

When pitched and has 4 to 5 runners, system will require a type 3 motor—which consists of one control board and 2 motors.

FLAT MAX DIMENSIONS TRAPEZOIDAL slack		
	Width	Projection
2 runner	197"	354"
3 runner	315"	354"
4 runner	472"	354"

# PERGOTENDA® B-SPACE



**B-Space** is a larger wall mounted retractable covering system custom made to size for the protection from sun and rain. It consists of an aluminum structure and a folding canvas. The canvas is supported by intermediate tubes (1.6"x2") and terminals (3.2"x2") set parallel to one another approximately every 24". The canvas moves by sliding on runners with anti-spray profile integrated by means of sliders on 6 asymmetrically arranged wheels with a capacity over 1000 lbs each. The toothed transmission belt contains stainless steel cables and resists a salt water environment; the tensile strength is of 2000 lbs at break; the transmission belt is inserted in each runner, controlled by the notched pulley and a single drive shaft and guarantees the smooth forward movement of the canvas. The Pergotenda® B Space system is operated by a radio-controlled Dunker D839 motor. Hardware and accessories are 304 stainless steel. While Corradi USA possesses a great deal of data related to engineering for the Pergotenda product line that is related to wind ratings and load data that has been developed through specific product tests, case studies and IBC testing. It is understood that when required and due to the custom nature of our projects, engineering must be project specific and adhere to the rules and regulations at the local level where such a project shall be planned and installed.

## FEATURES

**ANTIDRIP SYSTEM** Weldable PVC profile on the upper part of the canvas for lateral rainwater retention. This PVC profile is welded to each far side of a pitched roof canopy to prevent water from dripping over the sides and forces the water to shed into the gutter system.

**ANTISPRAY PROFILE** PVC profile inserted on the lateral side of the runner for retention of rainwater spray. Always in addition to the ANTIDRIP SYSTEM. The AntiSpray prevents water from a heavy downpour from "splashing" over the AntiDrip profile and dripping over the sides.

**MOTORIZATION** All Pergotenda® are motorized, giving you complete control at the touch of a button.

**HOOD** The Protective Hood Cover is an aluminum corrugated standing seam cover that is positioned where the unit mounts to the wall or at the back of the unit on a Freestanding model for the purpose of protecting the Roof Canopy Swags that created when the roof retracts and to prevent any water or debris from collecting in the swags. The Protective Hood Cover is powder coated for longevity.

## OPTIONS

**ADD-ON INTERMEDIATE SUPPORT TUBE** Used to reduce the height of the canopy swag when the roof unit is retracted, usually for purposes of clearing a door opening or a window. Only two (2) tubes total may be added to any single roof canopy.

**ADD-ON RUNNER** The mechanical Runner is the equivalent of roof truss or rafter and is what the roof canopy is attached to. Adding a Runner is considered when the roof pitch angle needs to be reduced to properly shed water and manage it into the gutter systems. Adding a runner may also be considered to reduce the pitch of the roof for design purposes as well.

**FAUX CEILING** A unique option that hangs a colorful fabric beneath the roofing material to add warmth and atmosphere to the room. The Faux Ceiling fabric can provide for an excellent opportunity to blend other colors or materials that are part of furnishings or cushions. The softer fabric material may also be a benefit in reducing noise or providing other minimal acoustic properties to dampen surrounding noise. This option will depend on the type of fabric. The Faux Ceiling fabric generally must be from the Corradi USA collection or an approved alternate.

**FRONT BEAM** Finishing aluminum profile for the closing application. Required in order to strengthen the structure with a projection over 157", but not necessary if front screens (Stratus) are applied.

**GABLE (pitched versions only)** A fixed fabric portion used to enclose the angled gap on both sides of a pitched system when using screens.

**LIGHTING** The Pergotenda® lighting system is a custom designed system that seamlessly integrates into the Pergotenda® intermediate tubes.

**PITCHED OR FLAT** Both pitched (angled) roof and flat roof options are available for the Impact.

**RETRACTABLE GUTTER** Extruded aluminum profile for rainwater collection, only for pitched versions, fixed to the end support tube. One drainage per runner. Down pipes not provided. The gutters moves with the roof canopy and has downspouts that merge into a CNC cut in each front supporting post.

**STRATUS SCREEN** An exterior screen specifically designed to integrate into most Pergotenda® systems for complete enclosure that assists in protection from the elements and gives the option of privacy.

**TRAPEZOIDAL FABRIC (flat versions only)** An alternative drainage option for flat systems to let you control which side of the system you want rain to fall off.

**UNDERSIDE DRIP-COLLECTION RIM (flat versions only)** Welded PVC profile on the underside of the roof canopy to channel water into the side gutters and to prevent water from running along the underside of the roof canopy and dripping down.

**WALL OR CEILING MOUNT** Available mounted to a wall or ceiling.

## FRAME COLORS

### POWDER COATING\*

The aluminum extrusions are painted with certified Qualicoat cycle epoxy powders. The support tubes come in: White Quartz, Glacier, & Beach Sand to match with the Eclissi fabric.



WHITE QUARTZ



ANTHRACITE



CARBON



GLACIER



BEACH SAND



DUNE



GRANITE



CORTEN



URBAN BRONZE

\*RAL CUSTOM COLOR POWDER COATING IS ALSO AVAILABLE

Due to print variation these finish images should not be used for final production specifications.

## FABRICS

### ECLISSI BLACKOUT FABRIC

Eclissi fabric is exclusively used by Corradi USA for Pergotenda® structures. It is a High tenacity 1100 Dtex Polyester base fabric with PVC laminate. The embossed finish on the inner side gives a textile appearance and a dynamic welt effect on the viewable surface. The outer side has an anti-dust acrylic lacquer. This unique 4-ply material has a blackout layer that also acts as a radiant barrier, providing superior heat resistance and heat gain as compared to other textiles used in these types of applications. It is available in 3 colors:



ECLISSI WHITE



ECLISSI GREY



ECLISSI IVORY

### OTHER RETRACTABLE ROOF FABRICS AVAILABLE

#### SERGE FERRARI SOLTIS PROOF W96

See Fabrics section pg. 155 for more information on this fabric.

#### SERGE FERRARI SOLTIS PROOF 502

See Fabrics section pg. 155 for more information on this fabric.

#### SERGE FERRARI SOLTIS PERFORM 92

See Fabrics section pg. 155 for more information on this fabric.

#### SERGE FERRARI SOLTIS HORIZON 86

See Fabrics section pg. 155 for more information on this fabric.

## MOTORS

### RADIO CONTROLLED DUNKER D839

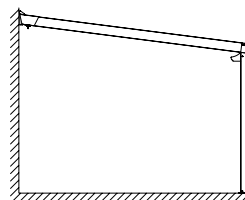

PITCHED MAX DIMENSIONS

	Width	Projection
2 runner	197"	354"
3 runner	354"	354"
4 runner	512"	354"
5 runner*	512"	354"

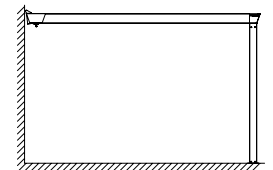

FLAT MAX DIMENSIONS

	Width	Projection
2 runner	138"	354"
3 runner	276"	354"
4 runner	413"	354"

FLAT MAX DIMENSIONS  
TRAPEZOIDAL slack

	Width	Projection
2 runner	197"	354"
3 runner	315"	354"
4 runner	472"	354"

\*5 runner available pitched only  
Note: when pitched and has 4 to 5 runners, system will require 2 motors.









# Pergotenda® Kubo



An aluminum modular Pergotenda® that includes all the bells and whistles. The Kubo can be either freestanding or wall mounted as well as linked together with other Kubos, making it easy to cover large spaces.

Time to come together



## Making Connections

Pergotenda® Kubo (2 top left) | Outdoor Living Solutions, London ON Canada

Pergotenda® Kubo with custom yellow frame color | Total Shade, Frisco TX

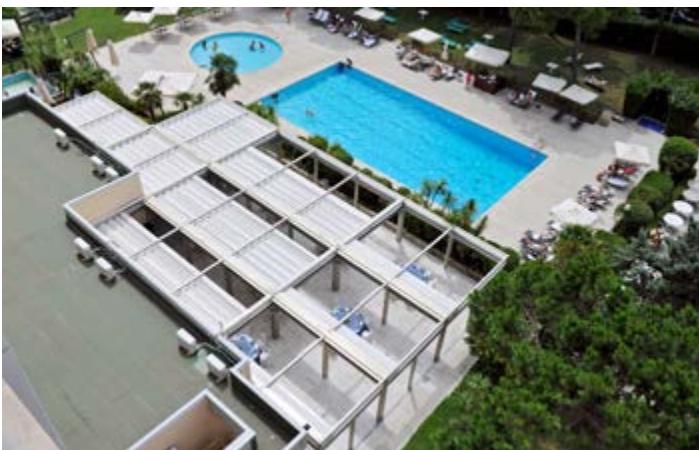

Holiday Inn | Rome, Italy

Piazza | Knokke-Heist, Belgium

# PERGOTENDA® KUBO



**Kubo** is a retractable, self-supporting or wall mounted cover system custom made to protect against sun and rain. It consists of an aluminum structure and a folding canvas. The fabric is supported by intermediate supporting tubes (1.6"x2") and terminal bars (3.2"x2") set parallel to one another every 20" approximately. The canvas moves by sliding on the runners (2"x3.5") on carriers with 6 asymmetrical wheels with a capacity of about 1000 lbs each. The toothed transmission belt has stainless steel cables and resists a saline environment; the tensile strength is of 2000 lbs at break; the transmission belt is inserted in each runner, controlled by the drive pulley and a single drive shaft that guarantees the smooth movement of the canvas. The KUBO system is operated by a radio-controlled Dunker D839 motor. Aluminum tubular structure 4.8"x4.8". Perimeter paneling is 0.2" thick, white opal methacrylate. Hardware and accessories are 304 stainless steel. While Corradi USA possesses a great deal of data related to engineering for the Pergotenda® product line that is related to wind ratings and load data that has been developed through specific product tests, case studies and IBC testing. It is understood that when required and due to the custom nature of our projects, engineering must be project specific and adhere to the rules and regulations at the local level where such a project shall be planned and installed.

## FEATURES

**ANTIDRIP SYSTEM** Weldable PVC profile on the upper part of the canvas for lateral rainwater retention. This PVC profile is welded to each far side of a pitched roof canopy to prevent water from dripping over the sides and forces the water to shed into the gutter system.

**ANTISPRAY PROFILE** PVC profile inserted on the lateral side of the runner for retention of rainwater spray. Always in addition to the ANTIDRIP SYSTEM. The AntiSpray prevents water from a heavy downpour from "splashing" over the AntiDrip profile and dripping over the sides.

**FLAT ONLY** The Kubo is only available flat.

**MODULAR** System modules can be connected for exponentially greater coverage.

**MOTORIZATION** All Pergotenda® are motorized, giving you complete control at the touch of a button.

**HOOD** The Protective Hood Cover is an aluminum corrugated standing seam cover that is positioned where the unit mounts to the wall or at the back of the unit on a Freestanding model for the purpose of protecting the Roof Canopy Swags that created when the roof retracts and to prevent any water or debris from collecting in the swags. The Protective Hood Cover is powder coated for longevity.

## OPTIONS

**ADD-ON INTERMEDIATE SUPPORT TUBE** Used to reduce the height of the canopy swag when the roof unit is retracted, usually for purposes of clearing a door opening or a window. Only two (2) tubes total may be added to any single roof canopy.

**ADD-ON RUNNER** The mechanical Runner is the equivalent of roof truss or rafter and is what the roof canopy is attached to. The Kubo may have up to a maximum of 4 runners.

**FAUX CEILING** A unique option that hangs a colorful fabric beneath the roofing material to add warmth and atmosphere to the room. The Faux Ceiling fabric can provide for an excellent opportunity to blend other colors or materials that are part of furnishings or cushions. The softer fabric material may also be a benefit in reducing noise or providing other minimal acoustic properties to dampen surrounding noise. This option will depend on the type of fabric. The Faux Ceiling fabric generally must be from the Corradi USA collection or an approved alternate.

**GABLE (pitched versions only)** A fixed fabric portion used to enclose the angled gap on both sides of a pitched system when using screens.

**LIGHTING** The Pergotenda® lighting system is a custom designed system that seamlessly integrates into the Pergotenda® intermediate tubes.

**RETRACTABLE GUTTER** Extruded aluminum profile for rainwater collection, only for pitched versions, fixed to the end support tube. One drainage per runner. Down pipes not provided. The gutters moves with the roof canopy and has downspouts that merge into a CNC cut in each front supporting post.

**STRATUS SCREEN** An exterior screen specifically designed to integrate into most Pergotenda® systems for complete enclosure that assists in protection from the elements and gives the option of privacy.

**TRAPEZOIDAL FABRIC (flat versions only)** An alternative drainage option for flat systems to let you control which side of the system you want rain to fall off.

**UNDERSIDE DRIP-COLLECTION RIM (flat versions only)** Welded PVC profile on the underside of the roof canopy to channel water into the side gutters and to prevent water from running along the underside of the roof canopy and dripping down.

**FREESTANDING OR WALL MOUNT** Can be attached to wall or self supporting.

## FRAME COLORS

### POWDER COATING\*

The aluminum extrusions are painted with certified Qualicoat cycle epoxy powders. The support tubes come in: White Quartz, Glacier, & Beach Sand to match with the Eclissi fabric.



WHITE QUARTZ



ANTHRACITE



CARBON



GLACIER



BEACH SAND



DUNE



GRANITE



CORTEN



URBAN BRONZE

\*RAL CUSTOM COLOR POWDER COATING IS ALSO AVAILABLE

Due to print variation these finish images should not be used for final production specifications.

## FABRICS

### ECLISSI BLACKOUT FABRIC

Eclissi fabric is exclusively used by Corradi USA for Pergotenda® structures.

It is a High tenacity 1100 Dtex Polyester base fabric with PVC laminate. The embossed finish on the inner side gives a textile appearance and a dynamic welt effect on the viewable surface. The outer side has an anti-dust acrylic lacquer. This unique 4-ply material has a blackout layer that also acts as a radiant barrier, providing superior heat resistance and heat gain as compared to other textiles used in these types of applications. It is available in 3 colors:



ECLISSI WHITE



ECLISSI GREY



ECLISSI IVORY

### OTHER RETRACTABLE ROOF FABRICS AVAILABLE

#### SERGE FERRARI SOLTIS PROOF W96

See Fabrics section pg. 155 for more information on this fabric.

#### SERGE FERRARI SOLTIS PROOF 502

See Fabrics section pg. 155 for more information on this fabric.

#### SERGE FERRARI SOLTIS PERFORM 92

See Fabrics section pg. 155 for more information on this fabric.

#### SERGE FERRARI SOLTIS HORIZON 86

See Fabrics section pg. 155 for more information on this fabric.

## MOTORS

### RADIO CONTROLLED DUNKER D839

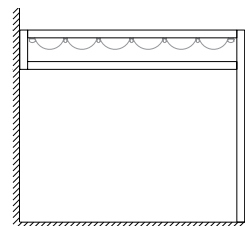

FLAT MAX DIMENSIONS  
STANDARD slack

	Width	Projection
2 runner	138"	236"
3 runner	276"	236"
4 runner	413"	236"

FLAT MAX DIMENSIONS  
TRAPEZOIDAL slack

	Width	Projection
2 runner	197"	236"
3 runner	315"	236"
4 runner	472"	236"



# Pergotenda® Millenium®



A contemporary Pergotenda® with seamless edges and a unified design, the Millenium® creates a uniquely modern atmosphere that complements any outdoor architecture.

Time to develop









## Moving forward



Pergotenda® Millenium® (2 bottom images) | The Dorchester Awning Company, Kingston MA  
The **Outdoor** Alchemist

# PERGOTENDA® MILLENIUM®



**Millenium®** is a retractable cover system mounted to a wall, custom made to protect against sun and rain. It consists of an aluminum structure and a folding canvas. This canvas is supported by intermediate supporting tubes (1.6"x2") and terminals (3.2"x2") set parallel to one another approximately every 24" (pitched version) and approximately every 20" (flat version). The canvas slides on support runners (2"x3.6") on 6 asymmetrical wheels with a capacity over 1000 lbs each. The toothed drive belt contains stainless steel cables and resists a saline environment; the tensile strength is of 2000 lbs. at break; the drive belt is inserted in each runner, controlled by the drive pulley and a single drive shaft and guarantees the smooth movement of the canvas. The Millenium system is operated by a radio-controlled Dunker D839 motor. Aluminum tubular structure 1.6"x4.7". Hardware and accessories are 304 stainless steel. While Corradi USA possesses a great deal of data related to engineering for the Pergotenda® product line that is related to wind ratings and load data that has been developed through specific product tests, case studies and IBC testing. It is understood that when required and due to the custom nature of our projects, engineering must be project specific and adhere to the rules and regulations at the local level where such a project shall be planned and installed.

## FEATURES

**ANTIDRIP SYSTEM** Weldable PVC profile on the upper part of the canvas for lateral rainwater retention. This PVC profile is welded to each far side of a pitched roof canopy to prevent water from dripping over the sides and forces the water to shed into the gutter system.

**ANTISPRAY PROFILE** PVC profile inserted on the lateral side of the runner for retention of rainwater spray. Always in addition to the ANTIDRIP SYSTEM. The AntiSpray prevents water from a heavy downpour from "splashing" over the AntiDrip profile and dripping over the sides.

**MOTORIZATION** All Pergotenda® are motorized, giving you complete control at the touch of a button.

**HOOD** The Protective Hood Cover is an aluminum corrugated standing seam cover that is positioned where the unit mounts to the wall or at the back of the unit on a Freestanding model for the purpose of protecting the Roof Canopy Swags that created when the roof retracts and to prevent any water or debris from collecting in the swags. The Protective Hood Cover is powder coated for longevity.

## OPTIONS

**ADD-ON INTERMEDIATE SUPPORT TUBE** Used to reduce the height of the canopy swag when the roof unit is retracted, usually for purposes of clearing a door opening or a window. Only two (2) tubes total may be added to any single roof canopy.

**ADD-ON RUNNER** The mechanical Runner is the equivalent of roof truss or rafter and is what the roof canopy is attached to. Adding a Runner is considered when the roof pitch angle needs to be reduced to properly shed water and manage it into the gutter systems. Adding a runner may also be considered to reduce the pitch of the roof for design purposes as well.

**FAUX CEILING** A unique option that hangs a colorful fabric beneath the roofing material to add warmth and atmosphere to the room. The Faux Ceiling fabric can provide for an excellent opportunity to blend other colors or materials that are part of furnishings or cushions. The softer fabric material may also be a benefit in reducing noise or providing other minimal acoustic properties to dampen surrounding noise. This option will depend on the type of fabric. The Faux Ceiling fabric generally must be from the Corradi USA collection or an approved alternate.

**FRONT BEAM** Finishing aluminum profile for the closing application. Required in order to strengthen the structure with a projection over 157", but not necessary if front screens (Stratus) are applied.

**GABLE (pitched versions only)** A fixed fabric portion used to enclose the angled gap on both sides of a pitched system when using screens.

**LIGHTING** The Pergotenda® lighting system is a custom designed system that seamlessly integrates into the Pergotenda® intermediate tubes.

**PITCHED OR FLAT** Both pitched (angled) roof and flat roof options are available for the Impact.

**RETRACTABLE GUTTER** Extruded aluminum profile for rainwater collection, only for pitched versions, fixed to the end support tube. One drainage per runner. Down pipes not provided. The gutters moves with the roof canopy and has downspouts that merge into a CNC cut in each front supporting post.

**STRATUS SCREEN** An exterior screen specifically designed to integrate into most Pergotenda® systems for complete enclosure that assists in protection from the elements and gives the option of privacy.

**TRAPEZOIDAL FABRIC (flat versions only)** An alternative drainage option for flat systems to let you control which side of the system you want rain to fall off.

**UNDERSIDE DRIP-COLLECTION RIM (flat versions only)** Welded PVC profile on the underside of the roof canopy to channel water into the side gutters and to prevent water from running along the underside of the roof canopy and dripping down.

**WALL OR CEILING MOUNT** Available mounted to a wall or ceiling.

## FRAME COLORS

### POWDER COATING\*

The aluminum extrusions are painted with certified Qualicoat cycle epoxy powders. The support tubes come in: White Quartz, Glacier, & Beach Sand to match with the Eclissi fabric.



WHITE QUARTZ



ANTHRACITE



CARBON



GLACIER



BEACH SAND



DUNE



GRANITE



CORTEN



URBAN BRONZE

\*RAL CUSTOM COLOR POWDER COATING IS ALSO AVAILABLE

Due to print variation these finish images should not be used for final production specifications.

## FABRICS

### ECLISSI BLACKOUT FABRIC

Eclissi fabric is exclusively used by Corradi USA for Pergotenda® structures. It is a High tenacity 1100 Dtex Polyester base fabric with PVC laminate. The embossed finish on the inner side gives a textile appearance and a dynamic welt effect on the viewable surface. The outer side has an anti-dust acrylic lacquer. This unique 4-ply material has a blackout layer that also acts as a radiant barrier, providing superior heat resistance and heat gain as compared to other textiles used in these types of applications. It is available in 3 colors:



ECLISSI WHITE



ECLISSI GREY



ECLISSI IVORY

### OTHER RETRACTABLE ROOF FABRICS AVAILABLE

#### SERGE FERRARI SOLTIS PROOF W96

See Fabrics section pg. 155 for more information on this fabric.

#### SERGE FERRARI SOLTIS PROOF 502

See Fabrics section pg. 155 for more information on this fabric.

#### SERGE FERRARI SOLTIS PERFORM 92

See Fabrics section pg. 155 for more information on this fabric.

#### SERGE FERRARI SOLTIS HORIZON 86

See Fabrics section pg. 155 for more information on this fabric.

## MOTORS

### RADIO CONTROLLED DUNKER D839

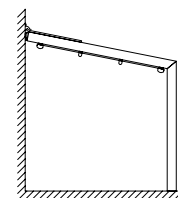

PITCHED MAX DIMENSIONS

	Width	Projection
2 runner	197"	232"
3 runner	354"	232"
4 runner	512"	232"
5 runner*	512"	232"

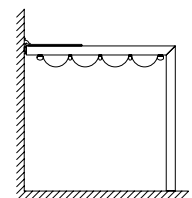

FLAT MAX DIMENSIONS

	Width	Projection
2 runner	138"	236"
3 runner	276"	236"
4 runner	413"	236"

FLAT MAX DIMENSIONS  
TRAPEZOIDAL slack

	Width	Projection
2 runner	197"	236"
3 runner	315"	236"
4 runner	472"	236"

\*5 runner available pitched only

Note: when pitched and has 4 to 5 runners, system will require 2 motors.



# Pergotenda® 45/60



The Pergotenda® 45 is our most traditional wood design. With the established look of a wall mounted wooden frame and the modern twist of the retractable roof to harmonize with any outdoor environment.

The Pergotenda® 60 has all the function and features of any wall mounted wood design, but on a grander scale.

Time to harmonize



Seasonal Rhythms





# PERGOTENDA® 45



**Pergotenda® 45** is a wall mounted retractable cover system custom made to protect against sun and rain. It consists of a laminated wood structure and a folding canvas. The fabric is supported by intermediate supporting tubes (1.6"x2") and terminal bars (3.2"x2") set parallel to one another every 24 inches approximately on pitched version and every 20 inches approximately on flat version. The canvas moves by sliding on the runners (2"x3.5") on carriers with 6 asymmetrical wheels with a capacity of about 1000 lbs each. The toothed transmission belt has stainless steel cables and resists a saline environment; the tensile strength is of 2000 lbs at break; the transmission belt is inserted in each runner, controlled by the drive pulley and a single drive shaft that guarantees the smooth movement of the canvas. The Pergotenda® 45 system is operated by a radio-controlled Dunker D839 motor. The structure, in autoclave treated Scandinavian pine wood (class 3 - UNI EN 335-3), is available in 1.75"x 6" and 4.7"x 4.7" sections. The aluminum runners, concealed in the wood rafters. Hardware and accessories are 304 stainless steel. While Corradi USA possesses a great deal of data related to engineering for the Pergotenda® product line that is related to wind ratings and load data that has been developed through specific product tests, case studies and IBC testing. It is understood that when required and due to the custom nature of our projects, engineering must be project specific and adhere to the rules and regulations at the local level where such a project shall be planned and installed.

## FEATURES

**ANTIDRIP SYSTEM** Weldable PVC profile on the upper part of the canvas for lateral rainwater retention. This PVC profile is welded to each far side of a pitched roof canopy to prevent water from dripping over the sides and forces the water to shed into the gutter system.

**ANTISPRAY PROFILE** PVC profile inserted on the lateral side of the runner for retention of rainwater spray. Always in addition to the ANTIDRIP SYSTEM. The AntiSpray prevents water from a heavy downpour from "splashing" over the AntiDrip profile and dripping over the sides.

**HOOD** The Protective Hood Cover is an aluminum corrugated standing seam cover that is positioned where the unit mounts to the wall or at the back of the unit on a Freestanding model for the purpose of protecting the Roof Canopy Swags that created when the roof retracts and to prevent any water or debris from collecting in the swags. The Protective Hood Cover is powder coated for longevity.

**MOTORIZATION** All Pergotenda® are motorized, giving you complete control at the touch of a button

## OPTIONS

**ADD-ON INTERMEDIATE SUPPORT TUBE** Used to reduce the height of the canopy swag when the roof unit is retracted, usually for purposes of clearing a door opening or a window. Only two (2) tubes total may be added to any single roof canopy.

**ADD-ON RUNNER** The mechanical Runner is the equivalent of roof truss or rafter and is what the roof canopy is attached to. Adding a Runner is considered when the roof pitch angle needs to be reduced to properly shed water and manage it into the gutter systems. Adding a runner may also be considered to reduce the pitch of the roof for design purposes as well.

**FAUX CEILING** A unique option that hangs a colorful fabric beneath the roofing material to add warmth and atmosphere to the room. The Faux Ceiling fabric can provide for an excellent opportunity to blend other colors or materials that are part of furnishings or cushions. The softer fabric material may also be a benefit in reducing noise or providing other minimal acoustic properties to dampen surrounding noise. This option will depend on the type of fabric. The Faux Ceiling fabric generally must be from the Corradi USA collection or an approved alternate.

**FIXED GUTTER (pitched versions only)** Extruded aluminum profile for rainwater collection fixed to the end support tube. Down pipes and accessories included.

**GABLE (pitched versions only)** A fixed fabric portion used to enclose the angled gap on both sides of a pitched system when using screens.

**LIGHTING** The Pergotenda® lighting system is a custom designed system that seamlessly integrates into the Pergotenda® intermediate tubes.

**PITCHED OR FLAT** Both pitched (angled) roof and flat roof options are available for the Impact.

**STRATUS SCREEN** An exterior screen specifically designed to integrate into most Pergotenda® systems for complete enclosure that assists in protection from the elements and gives the option of privacy.

**TRAPEZOIDAL FABRIC (flat versions only)** An alternative drainage option for flat systems to let you control which side of the system you want rain to fall off.

**UNDERSIDE DRIP-COLLECTION RIM (flat versions only)** Welded PVC profile on the underside of the roof canopy to channel water into the side gutters and to prevent water from running along the underside of the roof canopy and dripping down.

**WALL OR CEILING MOUNT** Available mounted to a wall or ceiling.

## FRAME COLORS

### WOOD STAIN\*

Scandinavian laminar pine wood used for wood Pergotenda® is structurally composed of layers glued together with adhesives that resist humidity. Pressure treated with mineral salts in an autoclave significantly increasing resistance to biological degradation. The support tubes come in: White Quartz, Glacier, & Beach Sand to match with the Eclissi fabric.



CHESTNUT



WALNUT



ANTHRACITE



WHITE

\*CUSTOM COLOR PAINTING IS ALSO AVAILABLE

Due to print variation these finish images should not be used for final production specifications.

## FABRICS

### ECLISSI BLACKOUT FABRIC

Eclissi fabric is exclusively used by Corradi USA for Pergotenda® structures. It is a High tenacity 1100 Dtex Polyester base fabric with PVC laminate. The embossed finish on the inner side gives a textile appearance and a dynamic weft effect on the viewable surface. The outer side has an anti-dust acrylic lacquer. This unique 4-ply material has a blackout layer that also acts as a radiant barrier, providing superior heat resistance and heat gain as compared to other textiles used in these types of applications. It is available in 3 colors:



ECLISSI WHITE



ECLISSI GREY



ECLISSI IVORY

## OTHER RETRACTABLE ROOF FABRICS AVAILABLE

### SERGE FERRARI SOLTIS PROOF W96

See Fabrics section pg. 145 for more information on this fabric.

### SERGE FERRARI SOLTIS PROOF 502

See Fabrics section pg. 145 for more information on this fabric.

### SERGE FERRARI SOLTIS PERFORM 92

See Fabrics section pg. 145 for more information on this fabric.

### SERGE FERRARI SOLTIS HORIZON 86

See Fabrics section pg. 145 for more information on this fabric.

## MOTORS

### RADIO CONTROLLED DUNKER D839

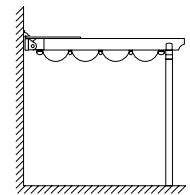
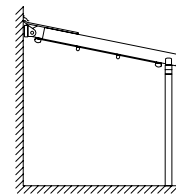

#### PITCHED MAX DIMENSIONS

	Width	Projection
2 runner	197"	232"
3 runner	354"	232"
4 runner	512"	232"
5 runner*	512"	232"

#### FLAT MAX DIMENSIONS

	Width	Projection
2 runner	138"	236"
3 runner	276"	236"
4 runner	413"	236"

#### FLAT MAX DIMENSIONS TRAPEZOIDAL slack

	Width	Projection
2 runner	197"	236"
3 runner	315"	236"
4 runner	472"	236"

\*5 runner available pitched only

Note: when pitched and has 4 to 5 runners, system will require 2 motors.



# PERGOTENDA® 60



**Pergotenda® 60** is a larger wall mounted retractable cover system custom made to protect against sun and rain. It consists of a laminated wood structure and a folding canvas. The fabric is supported by intermediate supporting tubes (1.6"x2") and terminal bars (3.2"x2") set parallel to one another every 24 inches approximately on pitched version and every 20 inches approximately on flat version. The canvas moves by sliding on the runners (2"x3.5") on carriers with 6 asymmetrical wheels with a capacity of about 1000 lbs each. The toothed transmission belt has stainless steel cables and resists a saline environment; the tensile strength is of 2000 lbs at break; the transmission belt is inserted in each runner, controlled by the drive pulley and a single drive shaft that guarantees the smooth movement of the canvas. The Pergotenda® 60 system is operated by a radio-controlled Dunker D839 motor. The structure, in autoclave treated Scandinavian pine wood (class 3 - UNI EN 335-3), is available in 2.4"x 8.6" and 4.7" x 4.7" sections. The aluminum runners are concealed in the wood rafters. Hardware and accessories are 304 stainless steel. While Corradi USA possesses a great deal of data related to engineering for the Pergotenda® product line that is related to wind ratings and load data that has been developed through specific product tests, case studies and IBC testing. It is understood that when required and due to the custom nature of our projects, engineering must be project specific and adhere to the rules and regulations at the local level where such a project shall be planned and installed.

## FEATURES

**ANTIDRIP SYSTEM** Weldable PVC profile on the upper part of the canvas for lateral rainwater retention. This PVC profile is welded to each far side of a pitched roof canopy to prevent water from dripping over the sides and forces the water to shed into the gutter system.

**ANTISPRAY PROFILE** PVC profile inserted on the lateral side of the runner for retention of rainwater spray. Always in addition to the ANTIDRIP SYSTEM. The AntiSpray prevents water from a heavy downpour from "splashing" over the AntiDrip profile and dripping over the sides.

**HOOD** The Protective Hood Cover is an aluminum corrugated standing seam cover that is positioned where the unit mounts to the wall or at the back of the unit on a Freestanding model for the purpose of protecting the Roof Canopy Swags that created when the roof retracts and to prevent any water or debris from collecting in the swags. The Protective Hood Cover is powder coated for longevity.

**MOTORIZATION** All Pergotenda® are motorized, giving you complete control at the touch of a button.

## OPTIONS

**ADD-ON INTERMEDIATE SUPPORT TUBE** Used to reduce the height of the canopy swag when the roof unit is retracted, usually for purposes of clearing a door opening or a window. Only two (2) tubes total may be added to any single roof canopy.

**ADD-ON RUNNER** The mechanical Runner is the equivalent of roof truss or rafter and is what the roof canopy is attached to. Adding a Runner is considered when the roof pitch angle needs to be reduced to properly shed water and manage it into the gutter systems. Adding a runner may also be considered to reduce the pitch of the roof for design purposes as well.

**FAUX CEILING** A unique option that hangs a colorful fabric beneath the roofing material to add warmth and atmosphere to the room. The Faux Ceiling fabric can provide for an excellent opportunity to blend other colors or materials that are part of furnishings or cushions. The softer fabric material may also be a benefit in reducing noise or providing other minimal acoustic properties to dampen surrounding noise. This option will depend on the type of fabric. The Faux Ceiling fabric generally must be from the Corradi USA collection or an approved alternate.

**FIXED GUTTER (pitched versions only)** Extruded aluminum profile for rainwater collection fixed to the end support tube. Down pipes and accessories included.

**GABLE (pitched versions only)** A fixed fabric portion used to enclose the angled gap on both sides of a pitched system when using screens.

**LIGHTING** The Pergotenda lighting system is a custom designed system that seamlessly integrates into the Pergotenda® intermediate tubes.

**PITCHED OR FLAT** Both pitched (angled) roof and flat roof options are available for the Impact.

**STRATUS SCREEN** An exterior screen specifically designed to integrate into most Pergotenda® systems for complete enclosure that assists in protection from the elements and gives the option of privacy.

**TRAPEZOIDAL FABRIC (flat versions only)** An alternative drainage option for flat systems to let you control which side of the system you want rain to fall off.

**UNDERSIDE DRIP-COLLECTION RIM (flat versions only)** Welded PVC profile on the underside of the roof canopy to channel water into the side gutters and to prevent water from running along the underside of the roof canopy and dripping down.

**WALL OR CEILING MOUNT** Available mounted to a wall or ceiling.

## FRAME COLORS

### WOOD STAIN\*

Scandinavian laminar pine wood used for wood Pergotenda® is structurally composed of layers glued together with adhesives that resist humidity. Pressure treated with mineral salts in an autoclave significantly increasing resistance to biological degradation. The support tubes come in: White Quartz, Glacier, & Beach Sand to match with the Eclissi fabric.



CHESTNUT



WALNUT



ANTHRACITE



WHITE

\*CUSTOM COLOR PAINTING IS ALSO AVAILABLE

Due to print variation these finish images should not be used for final production specifications.

## FABRICS

### ECLISSI BLACKOUT FABRIC

Eclissi fabric is exclusively used by Corradi USA for Pergotenda® structures. It is a High tenacity 1100 Dtex Polyester base fabric with PVC laminate. The embossed finish on the inner side gives a textile appearance and a dynamic weft effect on the viewable surface. The outer side has an anti-dust acrylic lacquer. This unique 4-ply material has a blackout layer that also acts as a radiant barrier, providing superior heat resistance and heat gain as compared to other textiles used in these types of applications. It is available in 3 colors:



ECLISSI WHITE



ECLISSI GREY



ECLISSI IVORY

## OTHER RETRACTABLE ROOF FABRICS AVAILABLE

### SERGE FERRARI SOLTIS PROOF W96

See Fabrics section pg. 155 for more information on this fabric.

### SERGE FERRARI SOLTIS PROOF 502

See Fabrics section pg. 155 for more information on this fabric.

### SERGE FERRARI SOLTIS PERFORM 92

See Fabrics section pg. 155 for more information on this fabric.

### SERGE FERRARI SOLTIS HORIZON 86

See Fabrics section pg. 155 for more information on this fabric.

## MOTORS

### RADIO CONTROLLED DUNKER D839

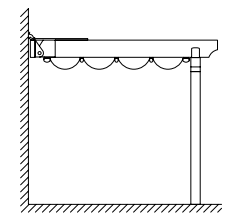
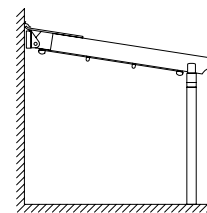

#### PITCHED MAX DIMENSIONS

	Width	Projection
2 runner	197"	307"
3 runner	354"	307"
4 runner	512"	307"
5 runner*	512"	307"

#### FLAT MAX DIMENSIONS

	Width	Projection
2 runner	138"	315"
3 runner	276"	315"
4 runner	413"	315"

#### FLAT MAX DIMENSIONS TRAPEZOIDAL slack

	Width	Projection
2 runner	197"	236"
3 runner	315"	236"
4 runner	472"	236"

\*5 runner available pitched only

Note: when pitched and has 4 to 5 runners, system will require 2 motors.



# Pergotenda® 100



The only wood Pergotenda® that is modular and can be freestanding or wall mounted, pitched or flat, as well as linked with other Pergotenda® 100s, making it easy to cover large spaces.

Time to grow



Pergotenda® 100 with Clear Vinyl Window Stratus Screens | Princi Italia, Plano TX

Pergotenda® 100 | Outdoor Living Solutions, London ON Canada

### Cultivate and flourish



# PERGOTENDA® 100



**Pergotenda® 100** is a modular freestanding or wall mounted retractable covering system custom made to protect against sun and rain. It consists of a glulam wood structure and a folding canvas. The fabric is supported by intermediate tubes (1.6"x2") and terminals (3.2"x2") set parallel approximately every 20". It slides on guides (2" x 3.6") with patented sliders that have 6 asymmetrical wheels with a maximum capacity of 1000 lbs each. The toothed drive belt inserted in each guide, with strands that are completely covered to resist even in saline environments, is driven by a pulley and a single transmission shaft to guarantee the uniform movement of the canvas. The breaking drive load of each belt is 2,000 lbs. The PT100 system is operated by a radio-controlled Dunker D839 motor. The structure, in autoclave treated Scandinavian pine wood (class 3 - UNI EN 335-3), is available in 4.7"x4.7" section, with added possibility of choosing different structure and board. Hardware and accessories are 304 stainless steel. While Corradi USA possesses a great deal of data related to engineering for the Pergotenda® product line that is related to wind ratings and load data that has been developed through specific product tests, case studies and IBC testing. It is understood that when required and due to the custom nature of our projects, engineering must be project specific and adhere to the rules and regulations at the local level where such a project shall be planned and installed.

## FEATURES

**ANTIDRIP SYSTEM** Weldable PVC profile on the upper part of the canvas for lateral rainwater retention. This PVC profile is welded to each side of a pitched roof canopy to prevent water from dripping over the sides and forces the water to shed into the gutter system.

**ANTISPRAY PROFILE** PVC profile inserted on the lateral side of the runner for retention of rainwater spray. Always in addition to the ANTIDRIP SYSTEM. The AntiSpray prevents water from a heavy downpour from "splashing" over the AntiDrip profile and dripping over the sides.

**MODULAR** System modules can be connected for exponentially greater coverage.

**MOTORIZATION** All Pergotenda® are motorized, giving you complete control at the touch of a button.

**HOOD** The Protective Hood Cover is an aluminum corrugated standing seam cover that is positioned where the unit mounts to the wall or at the back of the unit on a Freestanding model for the purpose of protecting the Roof Canopy Swags that created when the roof retracts and to prevent any water or debris from collecting in the swags. The Protective Hood Cover is powder coated for longevity.

## OPTIONS

**ADD-ON INTERMEDIATE SUPPORT TUBE** Used to reduce the height of the canopy swag when the roof unit is retracted, usually for purposes of clearing a door opening or a window. Only two (2) tubes total may be added to any single roof canopy.

**ADD-ON RUNNER** The mechanical Runner is the equivalent of roof truss or rafter and is what the roof canopy is attached to. Adding a Runner is considered when the roof pitch angle needs to be reduced to properly shed water and manage it into the gutter systems. Adding a runner may also be considered to reduce the pitch of the roof for design purposes as well.

**FAUX CEILING** A unique option that hangs a colorful fabric beneath the roofing material to add warmth and atmosphere to the room. The Faux Ceiling fabric can provide for an excellent opportunity to blend other colors or materials that are part of furnishings or cushions. The softer fabric material may also be a benefit in reducing noise or providing other minimal acoustic properties to dampen surrounding noise. This option will depend on the type of fabric. The Faux Ceiling fabric generally must be from the Corradi USA collection or an approved alternate.

**FIXED GUTTER (pitched versions only)** Extruded aluminum profile for rainwater collection fixed to the end support tube. Down pipes and accessories included.

**LIGHTING** The Pergotenda® lighting system is a custom designed system that seamlessly integrates into the Pergotenda® intermediate tubes.

**PITCHED OR FLAT** Both pitched (angled) roof and flat roof options are available for the Impact.

**STRATUS SCREEN** An exterior screen specifically designed to integrate into most Pergotenda® systems for complete enclosure that assists in protection from the elements and gives the option of privacy.

**TRAPEZOIDAL FABRIC (flat versions only)** An alternative drainage option for flat systems to let you control which side of the system you want rain to fall off.

**UNDERSIDE DRIP-COLLECTION RIM (flat versions only)** Welded PVC profile on the underside of the roof canopy to channel water into the side gutters and to prevent water from running along the underside of the roof canopy and dripping down.

**FREESTANDING OR WALL MOUNT** Can be attached to wall or self supporting.

## FRAME COLORS

### WOOD STAIN\*

Scandinavian laminar pine wood used for wood Pergotenda® is structurally composed of layers glued together with adhesives that resist humidity. Pressure treated with mineral salts in an autoclave significantly increasing resistance to biological degradation. The support tubes come in: White Quartz, Glacier, & Beach Sand to match with the Eclissi fabric.



CHESTNUT



WALNUT



ANTHRACITE



WHITE

\*CUSTOM COLOR PAINTING IS ALSO AVAILABLE

Due to print variation these finish images should not be used for final production specifications.

## FABRICS

### ECLISSI BLACKOUT FABRIC

Eclissi fabric is exclusively used by Corradi USA for Pergotenda® structures. It is a High tenacity 1100 Dtex Polyester base fabric with PVC laminate. The embossed finish on the inner side gives a textile appearance and a dynamic weft effect on the viewable surface. The outer side has an anti-dust acrylic lacquer. This unique 4-ply material has a blackout layer that also acts as a radiant barrier, providing superior heat resistance and heat gain as compared to other textiles used in these types of applications. It is available in 3 colors:



ECLISSI WHITE



ECLISSI GREY



ECLISSI IVORY

## OTHER RETRACTABLE ROOF FABRICS AVAILABLE

### SERGE FERRARI SOLTIS PROOF W96

See Fabrics section pg. 155 for more information on this fabric.

### SERGE FERRARI SOLTIS PROOF 502

See Fabrics section pg. 155 for more information on this fabric.

### SERGE FERRARI SOLTIS PERFORM 92

See Fabrics section pg. 155 for more information on this fabric.

### SERGE FERRARI SOLTIS HORIZON 86

See Fabrics section pg. 155 for more information on this fabric.

## MOTORS

### RADIO CONTROLLED DUNKER D839

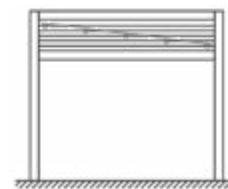

PITCHED MAX DIMENSIONS  
(1 MODULE)

	Width	Projection
2 runner	138"	276"
3 runner	276"	276"
4 runner	413"	276"



FLAT MAX DIMENSIONS  
(1 MODULE)

	Width	Projection
2 runner	138"	236"
3 runner	276"	236"
4 runner	413"	236"

\*Note: when pitched and has 4

runners, system will require 2 motors.

5 runner is not available with the PT100

whether pitched or flat.

FLAT MAX DIMENSIONS  
TRAPEZOIDAL slack

	Width	Projection
2 runner	138"	236"
3 runner	276"	236"
4 runner	472"	236"



# Pergotenda® Arko



A completely unique wood system that creates an unobstructed view. The Arko is the only Pergotenda® design that mounts to a wall without any pillar support.

Time to fly



Limitless





# PERGOTENDA® ARKO



**Arko** is a wall mounted retractable cover system custom made to protect against sun and rain. It consists of a laminated wood structure and a folding canvas. The fabric is supported by intermediate supporting tubes (1.6"x2") and terminal bars (3.2"x2") set parallel to one another every 24" approximately on pitched version and every 20" approximately on flat version. The canvas moves by sliding on the runners (2"x3.5") on runners with 6 asymmetrical wheels with a capacity of about 1000 lbs each. The toothed transmission belt has stainless steel cables and resists a saline environment; the tensile strength is of 2000 lbs at break; the transmission belt is inserted in each runner, controlled by the drive pulley and a single drive shaft that guarantees the smooth movement of the canvas. The Arko system is operated by a radio-controlled Dunker D839 motor. The structure, in autoclave treated Scandinavian pine wood (class 3 - UNI EN 335-3), is available in 1.8"x6", 3.5"x4.8" sections. The aluminum runners are concealed in the wood rafters. Hardware and accessories are 304 stainless steel. While Corradi USA possesses a great deal of data related to engineering for the Pergotenda product line that is related to wind ratings and load data that has been developed through specific product tests, case studies and IBC testing. It is understood that when required and due to the custom nature of our projects, engineering must be project specific and adhere to the rules and regulations at the local level where such a project shall be planned and installed.

## FEATURES

**ANTIDRIP SYSTEM** Weldable PVC profile on the upper part of the canvas for lateral rainwater retention. This PVC profile is welded to each far side of a pitched roof canopy to prevent water from dripping over the sides and forces the water to shed into the gutter system.

**ANTISPRAY PROFILE** PVC profile inserted on the lateral side of the runner for retention of rainwater spray. Always in addition to the ANTIDRIP SYSTEM. The AntiSpray prevents water from a heavy downpour from "splashing" over the AntiDrip profile and dripping over the sides.

**MOTORIZATION** All Pergotenda® are motorized, giving you complete control at the touch of a button.

**HOOD** The Protective Hood Cover is an aluminum corrugated standing seam cover that is positioned where the unit mounts to the wall or at the back of the unit on a Freestanding model for the purpose of protecting the Roof Canopy Swags that created when the roof retracts and to prevent any water or debris from collecting in the swags. The Protective Hood Cover is powder coated for longevity.

**WALL MOUNT ONLY** Mounted to a wall installation.

## OPTIONS

**ADD-ON INTERMEDIATE SUPPORT TUBE** Used to reduce the height of the canopy swag when the roof unit is retracted, usually for purposes of clearing a door opening or a window. Only two (2) tubes total may be added to any single roof canopy.

**ADD-ON RUNNER** The mechanical Runner is the equivalent of roof truss or rafter and is what the roof canopy is attached to. Adding a Runner is considered when the roof pitch angle needs to be reduced to properly shed water and manage it into the gutter systems. Adding a runner may also be considered to reduce the pitch of the roof for design purposes as well.

**LIGHTING** The Pergotenda® lighting system is a custom designed system that seamlessly integrates into the Pergotenda® intermediate tubes.

**FIXED GUTTER (pitched versions only)** Extruded aluminum profile for rainwater collection fixed to the end support tube. Down pipes and accessories included.

**FAUX CEILING** A unique option that hangs a colorful fabric beneath the roofing material to add warmth and atmosphere to the room. The Faux Ceiling fabric can provide for an excellent opportunity to blend other colors or materials that are part of furnishings or cushions. The softer fabric material may also be a benefit in reducing noise or providing other minimal acoustic properties to dampen surrounding noise. This option will depend on the type of fabric. The Faux Ceiling fabric generally must be from the Corradi USA collection or an approved alternate.

**RETRACTABLE GUTTER** Extruded aluminum profile for rainwater collection fixed to the end support tube. One drainage per runner.

## FRAME COLORS

### WOOD STAIN\*

Scandinavian laminar pine wood used for wood Pergotenda® is structurally composed of layers glued together with adhesives that resist humidity. Pressure treated with mineral salts in an autoclave significantly increasing resistance to biological degradation. The support tubes come in: White Quartz, Glacier, & Beach Sand to match with the Eclissi fabric.



CHESTNUT



NATURAL



WALNUT



ANTHRACITE



WHITE

\*CUSTOM COLOR PAINTING IS ALSO AVAILABLE

Due to print variation these finish images should not be used for final production specifications.

## FABRICS

### ECLISSI BLACKOUT FABRIC

Eclissi fabric is exclusively used by Corradi USA for Pergotenda® structures. It is a High tenacity 1100 Dtex Polyester base fabric with PVC laminate. The embossed finish on the inner side gives a textile appearance and a dynamic weft effect on the viewable surface. The outer side has an anti-dust acrylic lacquer. This unique 4-ply material has a blackout layer that also acts as a radiant barrier, providing superior heat resistance and heat gain as compared to other textiles used in these types of applications. It is available in 3 colors:



ECLISSI WHITE

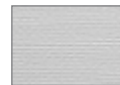

ECLISSI GREY



ECLISSI IVORY

## OTHER RETRACTABLE ROOF FABRICS AVAILABLE

### SERGE FERRARI SOLTIS PROOF W96

See Fabrics section pg. 155 for more information on this fabric.

### SERGE FERRARI SOLTIS PROOF 502

See Fabrics section pg. 155 for more information on this fabric.

### SERGE FERRARI SOLTIS PERFORM 92

See Fabrics section pg. 155 for more information on this fabric.

### SERGE FERRARI SOLTIS HORIZON 86

See Fabrics section pg. 155 for more information on this fabric.

## MOTORS

### RADIO CONTROLLED DUNKER D839

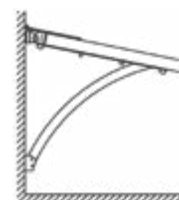

### PITCHED (only) MAX DIMENSIONS

	Width	Projection
2 runner	157"	157"
3 runner	315"	157"
4 runner	472"	157"

\*Note: When 4 runners, the Arko will require 2 motors.

The Arko is only available in pitched.

5 runner is not available with the Arko.

Pergotenda®  
Weather





## Wind resistance classification

EN 13561:2015 CLASS		0	1	2	3	4	5	6
NOMINAL WIND PRESSURE	(N/m <sup>2</sup> )	0	40	70	110	170	270	400
WIND VELOCITY	(m/s)	0	8	11	13	16	21	25
	(km/h)	0	29	38	48	59	75	91
BEAUFORT DEGREE		0	4	5	6	7	8	9
RANGE OF WIND VELOCITY	(km/h)		20 - 29	30 - 39	40 - 50	51 - 62	63 - 75	76 - 87
ENVIRONMENTAL CONDITIONS			Moderate breeze	Fresh breeze	Strong breeze	Strong wind	Fresh gale	Strong gale



### SNOW

Whereas Pergotenda® is often utilized in regions with snowy winters, it has not been officially tested and cannot be guaranteed for specific snow loads.

Pergotenda®  
Accessories

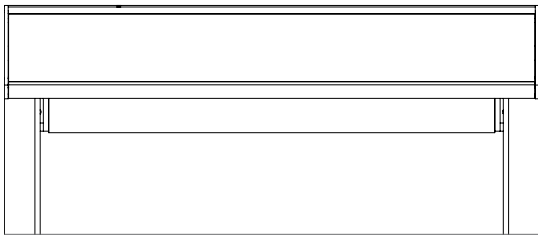

# Stratus Screen

for Pergotenda®



Millenium® with Stratus Solar Screens & ShyZip® Tracks  
Corradi Italy, Bologna IT



Pergotenda® Palladia® with Stratus Clear Vinyl Window Screens & ShyZip® Tracks  
New Haven Awning, New Haven CT

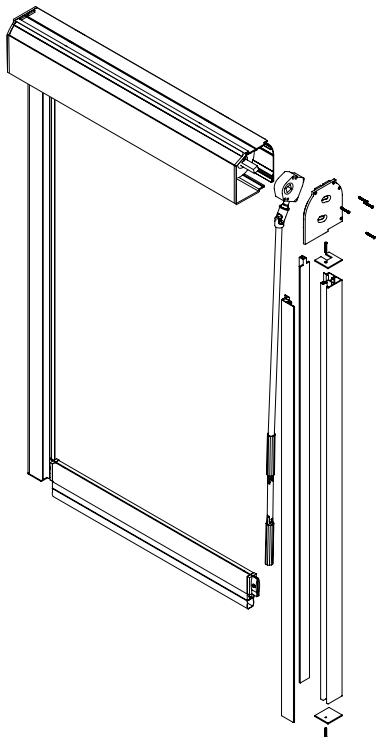

The Stratus is an exterior screen specifically designed to integrate into most Pergotenda® systems for complete enclosure that assists in protection from the elements and gives the option of privacy. The design of the Stratus is based off of our long-standing proprietary Summit exterior screen.

The Stratus is installed with specially designed jamb mount brackets that fit perfectly into any applicable Pergotenda® system. It is recommended to use ShyZip® track for complete enclosure on a Pergotenda® unit. The Stratus is available both motorized or manual (with some size restrictions).

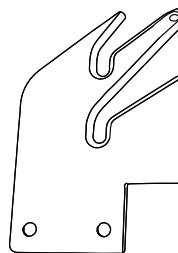

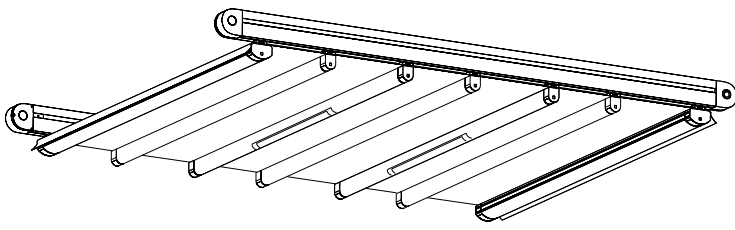

# Lighting

for Pergotenda®



The Pergotenda® lighting system is a custom designed system that seamlessly integrates into the Pergotenda® intermediate tubes.

This superior lighting system adds atmosphere and even more control extending the usage hours of your outdoor space. The lighting system uses an IP 65 outdoor rated, monochromatic LED that is encased in beveled clear silicon cover and inserted into aluminum profile with frosted white polycarbonate diffuser.

Pergotenda® lights are supplied pre-wired to clear sleeve low voltage cable pigtailed with fully sealed waterproof end connections, for easy daisy chaining to additional strips. The power to the strips is supplied by dedicated extension cables with waterproof plugs and sockets, designed to guarantee a quick and secure hook-up both to the strips and single power supply unit, available and furnished in different wattages depending on the number of lighting strips used, up to a maximum of 24 fixtures total per power supply. The strips come with preapplied 3M adhesive back tape for outdoor use.

**Key features: IP 65 damp outdoor use, remote with 4 pre-set intensity levels and dimmer, 3400K warm white, 24V, plug-and-play ready, maximum practicality for easy retrofits, kit designed to perfectly integrate with every Pergotenda® system already installed.**



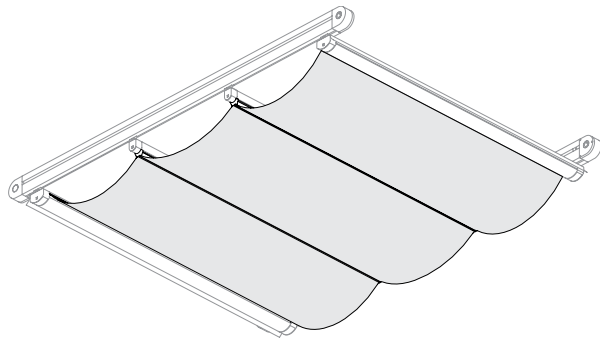

# Faux Ceiling

for Pergotenda®

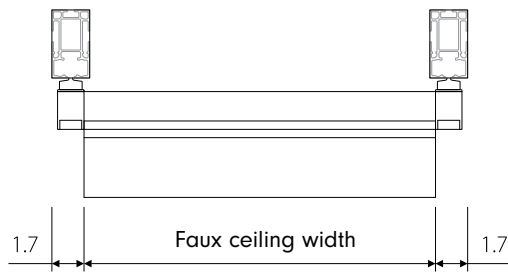

Faux ceilings are an adaptation of the intermediate tubes that make it possible to apply decorative canvas fabrics to the Pergotenda® Impact system.

The Para Tempotest® Home Solids collection is the fabric used for Faux ceilings. It is a proprietary soft fashion fabric that is available in a variety of rich solid colors to help create ambiance to match any atmosphere you wish to create. See Para Tempotest® Home Solids fabric sample collection for reference.

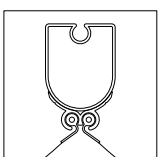

CANVAS FIXED TO INTERMEDIATE SUPPORT TUBES

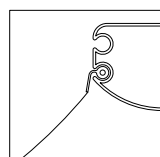

CANVAS FIXED TO END SUPPORT TUBES

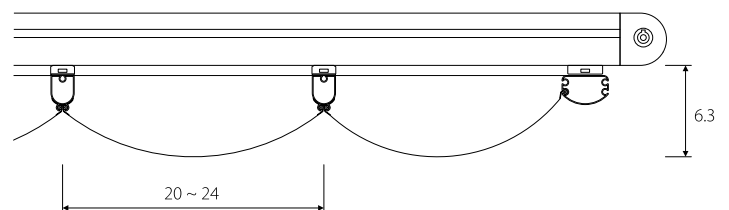

# Gable

for Pergotenda®

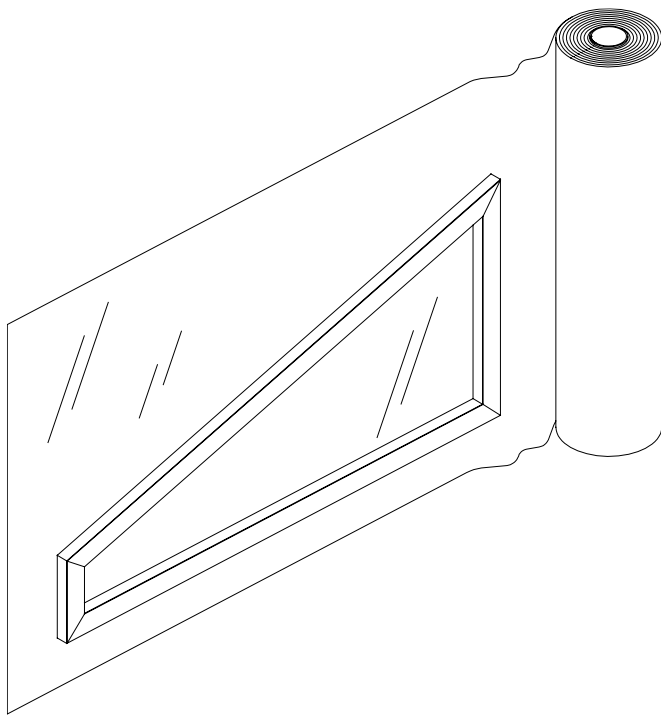
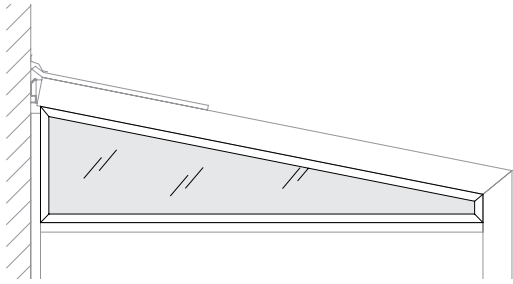

Gables are finishing profiles for setting up the lateral triangular openings for pitched Pergotenda®.

They are most often implemented when using the Stratus Screen or for custom enclosure and structural designs. Gables often have a taut fabric stretched over the trapezoidal opening created by the pitch that helps to complete the enclosure. Gable coverings are available in various fabrics, such as Clear Vinyl, Eclissi, or Serge Ferrari® Soltis® Proof 502.

PERGOTENDA® 45;  
PERGOTENDA® 60  
(wood profiles)

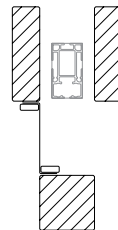

PERGOTENDA®  
PALLADIA® ; MILLENIUM®  
(aluminium profiles)

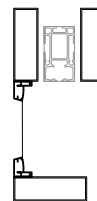

PERGOTENDA®  
Palladia®  
(aluminium profiles)



PERGOTENDA®  
B SPACE  
(aluminium profiles)







Corradi





# Louvered Roof Systems

Louvered Roof Systems, often known as louvered pergolas or bioclimatic systems, consist of rotating aluminum louvers for premium control over the climate of your outdoor space with ease and sophistication.





# Louvered Roof Pergolas

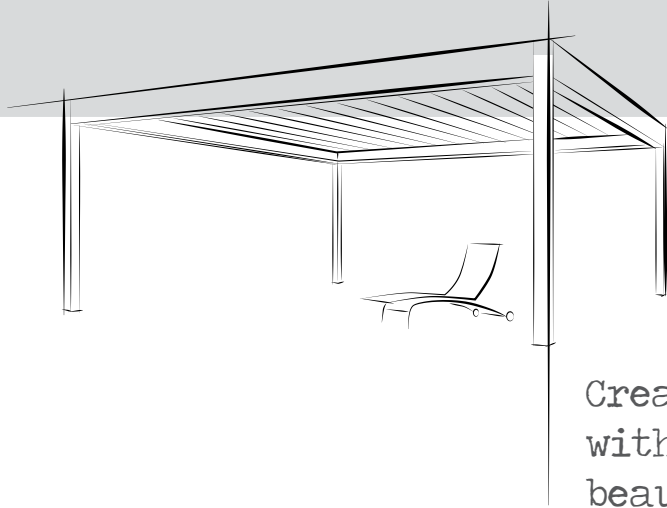

Create your own bioclimate with maximum control and beautiful design.

Corradi's louvered roof pergolas are aluminum outdoor structures equipped with rotating blades that can be adjusted by remote control. The rotation of the blades creates an environment

that is particularly comfortable in all seasons, as by changing their angle you can control the sunlight and the degree of natural ventilation in the environment below, thereby adjusting the temperature.

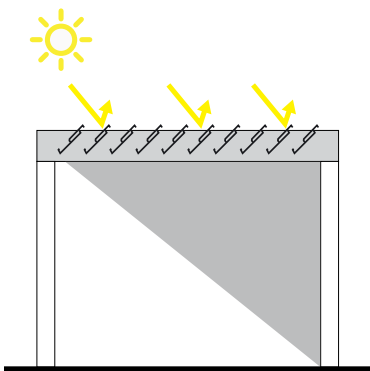

Sun protection

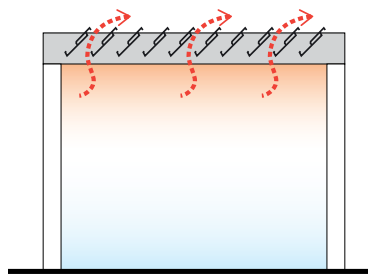

Ventilation

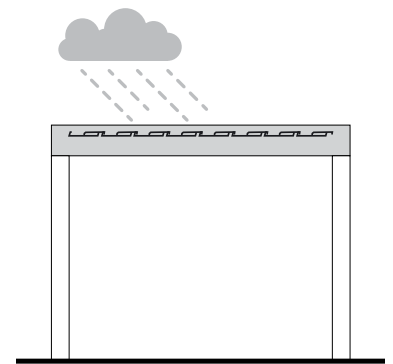

Resistance to rain

## Blades direction of rotation

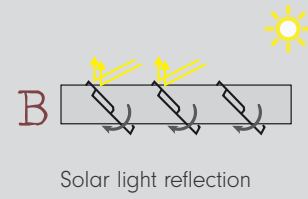
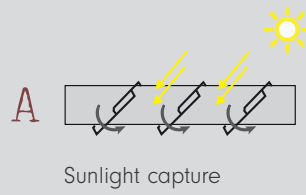

This creates a custom microclimate to meet your needs, while with the blades fully closed the space below is protected from the weather. Corradi has combined this great practicality with its unmistakable Sense of design and cutting-edge technical solutions, creating an elegant mix of functionality and style.







# Alba

## Louvered Roof System



Alba is a louvered pergola fitted with aluminum blades that can rotate up to 150° using a wireless control to adjust light, ventilation, and protection from the elements.

Time to plan





Corradi





Alba is a bioclimatic pergola fitted with aluminum blades that can be oriented up to 150° using a wireless control to adjust light and ventilation.

When completely closed, the upper cover is water resistant and the water is drained by a gutter system integrated in the pillars. Blades are convex and meant to channel water toward the sides even when they are opened after a rainstorm.

Alba's structure is made up of two different profiles: the front one, parallel to the blades, can contain a gutter system; the longitudinal one, perpendicular to the blades, is always provided with a gutter system and a drip guard that limits water dripping. For more protection you can complete Alba with Corradi's exterior screens.



To continue enjoying your outdoor space, even at night, you can choose LED lighting that can be fitted in the blades. Lights are fully dimmable to create the perfect atmosphere for every occasion.

### **Quality and function**



Alba Louvered Roof | The Deck Awning Company, Gaithersburg MD

Pictured here is the very first Alba installation on North American soil.



Alba Louvered Roof System



The owner of The Deck Awning Company installed an Alba Liberty integrated into a custom cantilevered frame in his own backyard.

Alba Louvered Roof | The Deck Awning Company, Gaithersburg MD





# ALBA Louvered Roof System



**Alba** louvered roof pergolas are aluminum outdoor structures equipped with adjustable blades that can be rotated by remote control. The rotation of the blades creates an environment that is particularly comfortable in all seasons, as by changing their angle you can control the sunlight and the degree of natural ventilation in the environment below, thereby adjusting the temperature. This creates a custom microclimate to meet your needs, while with the blades fully closed the space below is protected from the weather. When completely closed, the roof is waterproof and a gutter system is integrated into the pillars for drainage. Blades are convex and meant to channel water toward the sides even when they are opened after a rainstorm. Alba's structure is made up of two different profiles: the front one, parallel to the blades, can contain a gutter system; the longitudinal one, perpendicular to the blades, is always provided with a gutter system and a drip guard that limits water dripping. For more protection you can complete Alba with Corradi's screens and other perimeter enclosures.

## FRAME COLORS

### POWDER COATING\*

The aluminum extrusions are painted with certified Qualicoat cycle epoxy powders. The support tubes come in: White Quartz, Glacier, & Beach Sand to match with the Eclissi fabric.



\*RAL CUSTOM COLOR POWDER COATING IS ALSO AVAILABLE  
Due to print variation these finish images should not be used for final production specifications.

## MOTORS

### RADIO CONTROLLED

Alba's motor, fitted on the single longitudinal side, is housed inside a 5"x20" weatherproof enclosure mounted on top of the structure. When blades are set to fully open position, they remain visible on the exterior side exceeding the total height by 3.75".

## Modules

	Single module	Double module	No. Pillars	Installation type
<b>FREESTANDING</b>			4	1
<b>WALL-MOUNTED</b>			2	2.1 Blades    on load bearing structure
<b>LONGITUDINAL WALL-MOUNTED</b>			2	2.2 Blades ⊥ on load bearing structure
<b>WALL-MOUNTED</b>			1	2.3 Blades ⊥ and    on load bearing structure
<b>ALBA LIBERTY INTEGRATED</b>			0	3
<b>ALBA LIBERTY RESTING</b>			0	4

<b>MAXIMUM DIMENSIONS</b>	177 x 238 in	single module
	236 x 238 in	double module
<b>TOTAL HEIGHT</b>	110 in	standard
	138 in	max
<b>PILLAR SECTION</b>	4 x 4 in	
<b>BEAM SECTION</b>	4 x 9 in	
<b>BLADE SECTION</b>	8.5 in	
<b>WATER RESISTANCE</b>	830 gallons/hr 2 drains open	
<b>MAXIMUM PAY LOAD *</b>	22.53 lbs / sq ft on 11'2" x 19' system	

\* The maximum pay load is calculated with closed blades and 110 inches of height passage, thus in the worst-case situation. In case of snow, it is advisable to position the blades at 90° to avoid excessive accumulations.

WIND RESISTANCE UP TO 75 miles/hour with closed blades

## FEATURES

- ALUMINUM
- FLAT
- INTEGRATED GUTTER
- MOTORIZED OPERATION
- RESISTANCE TO INCLEMENT WEATHER
- WIND RESISTANCE

## OPTIONS

- LED LIGHTS
- OFFSET PILLAR
- RAIN SENSOR
- SCREENS
- WALL MOUNT OR FREESTANDING
- WIND SENSOR





Corradi

# Exterior Solar Screens



Exterior solar screens are retractable vertical screens that provide protection from the harsh sun and provide options for light wind, light rain, and insect protection.



Summit with ShyZip® Tracks (bottom left)  
and Vista with ShyZip® Tracks (bottom right)  
Conroe Awning and Screen, Conroe, TX



# Exterior Solar Screens

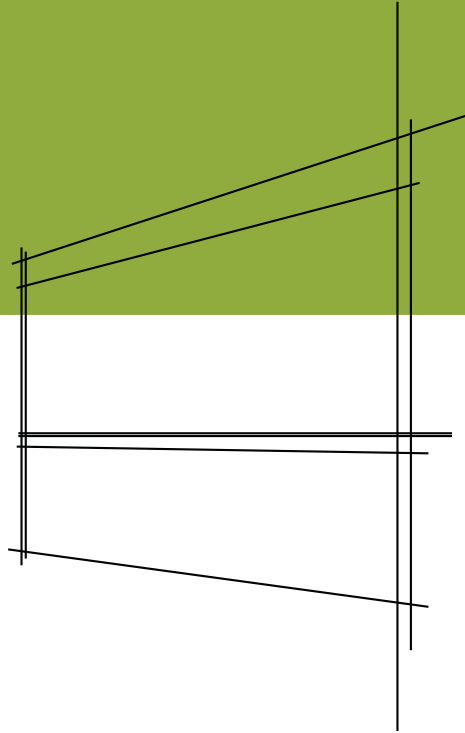

Make shade, save energy,  
stop bugs, and enjoy the view.

Manual or motorized, wide variations of fabric opacity, high quality brand solar fabrics, and a sophisticated collection of frame colors are the perfect ingredients for the right solar screen fit.



Summit | Longhorn Solar Screens, Denton TX

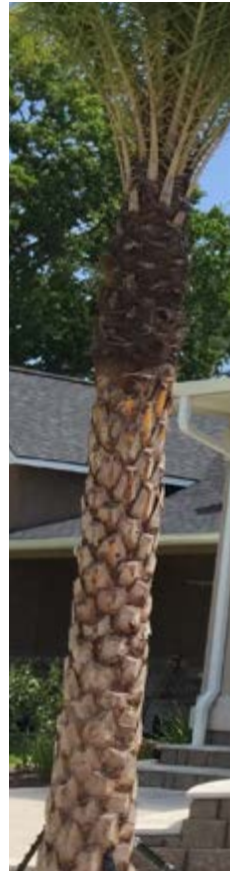

Summit

Harbor

Vista

Horizon



Summit with ShyZip® Tracks | Conroe Awning, Conroe, TX

Create relief from the blinding sun and protect yourself and others from harmful UV rays without blocking your view of the landscape. Block up to 97% of the sun's heat by installing a screen on the outside of your building—of which not only improves the comfort of inhabitants inside, but significantly reduces the need for energy expenditure on air conditioning. Increase privacy and block annoying insects from your

outdoor area. Corradi's versatile drop shade systems are ideal for all types of exterior commercial and residential applications including offices, restaurants, and hotels, solving virtually every outdoor solar protection need. Enjoy your surroundings with the protection and ease of Corradi USA's exterior solar shade systems.





# Summit

Exterior Solar Screen

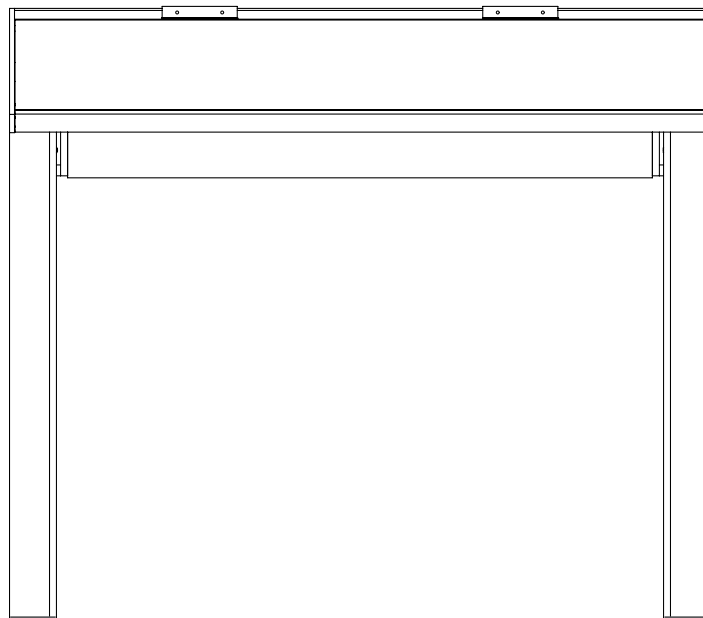

Corradi USA's leading cassette system, the Summit is adaptable to almost every outdoor screen and shade application.

Time to rise above



Summit with ShyZip® Tracks | We Got You Covered Outdoor, Mooresville NC



Summit with ShyZip® Tracks | Conroe Awning and Screen, Conroe TX



Summit with ShyZip® Tracks | The Dorchester Awning Company, Kingston, MA

Summit with ShyZip® Tracks | Longhorn Solar Screens, Denton TX

**Command your surroundings**

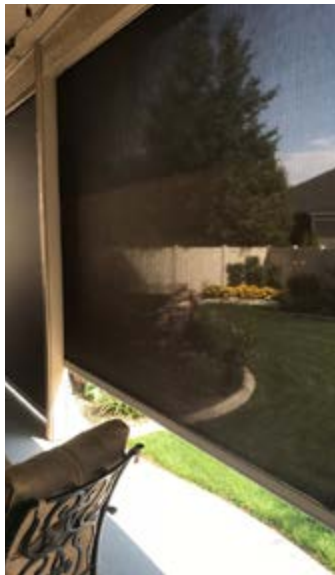

Summit with ShyZip® Tracks | Blind Appeal, Nampa ID



Summit with ShyZip® Tracks | Blind Appeal, Nampa ID



Enhance the atmosphere

# SUMMIT Exterior Solar Screen



**Summit** is the industry's benchmark shading system exclusively manufactured and sold by Corradi USA. The base model is manual gear operated with a detachable click-on crank, no side tracks, and a heavy duty bottom rail. The headbox/cassette has the option of a curved front or square front. Upgrade track options include the ShyZip® Spring fabric retention system or stainless steel cable guides for both manual or motorized.

The manual option includes a detachable clicking crank with an inconspicuous foldable handle. The detachable crank can be used on a manual shade up to the manual maximum length of 16' wide. Motor configurations include a wired switch controlled motor or wireless remote controlled motor. Corradi offers the latest motors from Somfy® and other name brands. Any shade more than 16' wide must be motorized. Also, the wireless options can be used with a sun & wind sensor to automatically operate under specific conditions. The Summit is delivered ready to install with standard easy-to-use ceiling brackets. A wall bracket is available as an upgrade.

## IDEAL APPLICATIONS

**WINDOWS INSTALLED AS AN EXTERIOR APPLICATION**

**GARAGE DOOR OPENINGS, MAKING THE GARAGE A MULTI-USE AND INSECT FREE ROOM**

**PATIO COVERS TO CREATE AN INSECT PROOF SCREENED-IN PORCH AT THE TOUCH OF A BUTTON**

**BLACKOUT SHADES THAT PROVIDE THE ULTIMATE ROOM DARKENING EFFECT**

**SKYLIGHTS (WITH USE OF CONSTON BOX TENSION DESIGN)**

**OUTDOOR RESTAURANT DINING AREAS**

**OUTDOOR SMOKING AREAS**

**RESIDENTIAL AND COMMERCIAL VERANDAS**

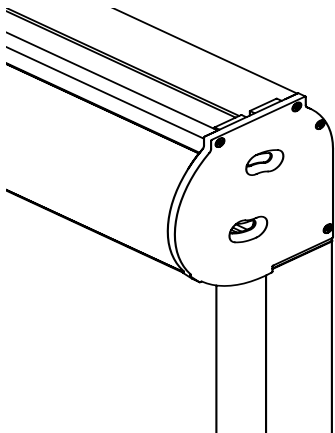

Standard Curved Front Option

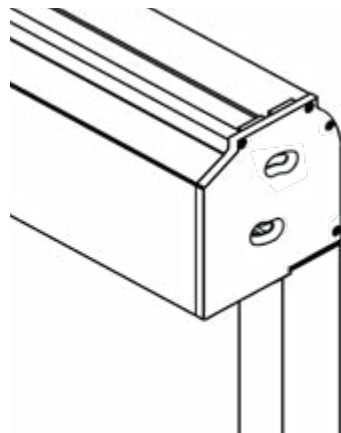

Special Square Front Option

## FRAME COLORS

### POWDER COATING\*

The aluminum extrusions are painted with certified Qualicoat cycle epoxy powders.



WHITE QUARTZ



ANTHRACITE



CARBON



GLACIER



BEACH SAND



DUNE



GRANITE



CORTEN



URBAN BRONZE

\*RAL CUSTOM COLOR POWDER COATING IS ALSO AVAILABLE  
Due to print variation these finish images should not be used for final production specifications.

## FABRICS

**Corradi USA offers a wide variety of fabrics for exterior solar screens. Listed below are standard and recommended fabrics available.**

### PHIFER

Solar protection fabrics with a wide range of openness

<b>SHEERWEAVE:</b>	<b>SUNTEX:</b>	<b>TUFFSCREEN</b>
2000, 2100, 2360, 2390, 2410, 2500, 4000, 4100, and more...	80, 90, & 95	

### SERGE FERRARI

Preconstraint tension vinyl and solar protection fabrics.

<b>SOLTIS PROOF W96</b>	<b>SOLTIS HORIZON 86</b>
<b>SOLTIS PROOF 502</b>	<b>SOLTIS HARMONY 88</b>
<b>SOLTIS PERFORM 92</b>	<b>SOLTIS OPAQUE B92</b>

### TEMPOTEST USA

Vibrant and durable injection dyed acrylic and solar protection fabrics.

**SOLID ACRYLICS**  
**SOLID ACRYLICS FR**

### CLEAR VINYL WINDOWS WITH BORDERS

Protect from rain & keep the view. Clear vinyl windows include borders that can be constructed from vinyl coated textiles or acrylic fabrics. Max height for clear vinyl is 108".

### OTHER FABRICS APPLICABLE\*

These are fabric brands that may be used but are not standard:

Sunbrella Standard Acrylics      Sunbrella Premium Acrylics

\*Check with your authorized dealer for any other fabric options

## MOTORS

**SOMFY® 500 STARHEAD SERIES (MAESTRIA)**

## KEY DETAILS

**Max Width\*: 216"**

**Max Height\*\*: 192"**

**Clear Vinyl Max Height: 108"**

\*Manual units can only be made up to a 16' (192") width.

\*\*Maximum height may be less for certain fabrics.





# Harbor

Exterior Solar Screen

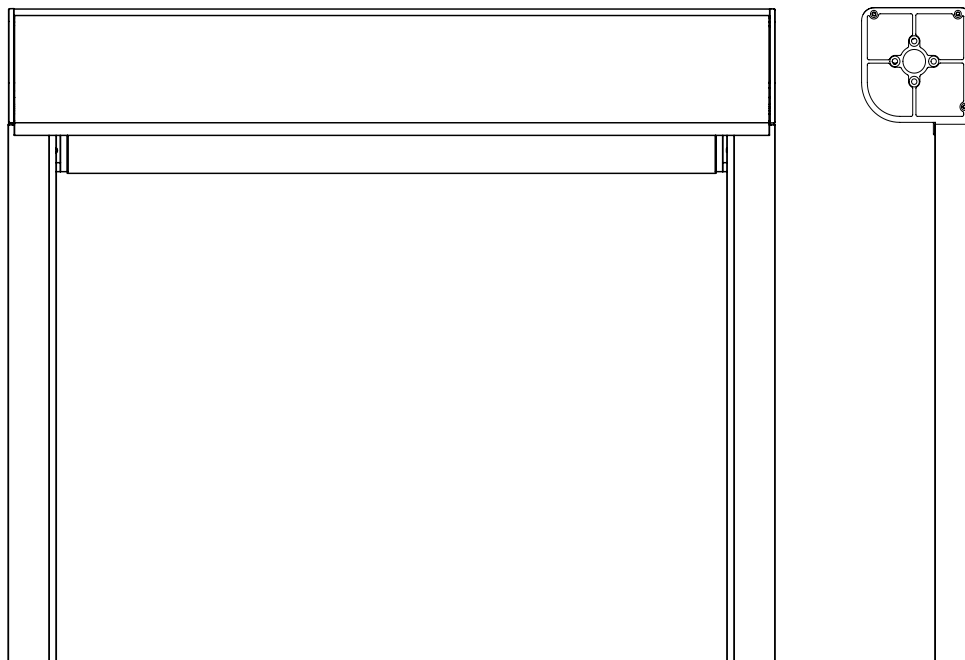

A substantial cassette system with larger and sturdier roll-tube, the Harbor is perfect for projects requiring widths that exceed 20' as well as longer drop-lengths on thicker fabrics.

Time to expand



Harbor with ShyZip® Tracks | Window Products Management, Ventura CA



Harbor with ShyZip® Tracks  
Longhorn Solar Screens, Denton TX



Harbor with ShyZip® Tracks | Kraft Mobile Screen Service, Wilsonville CA





Relax in comfort



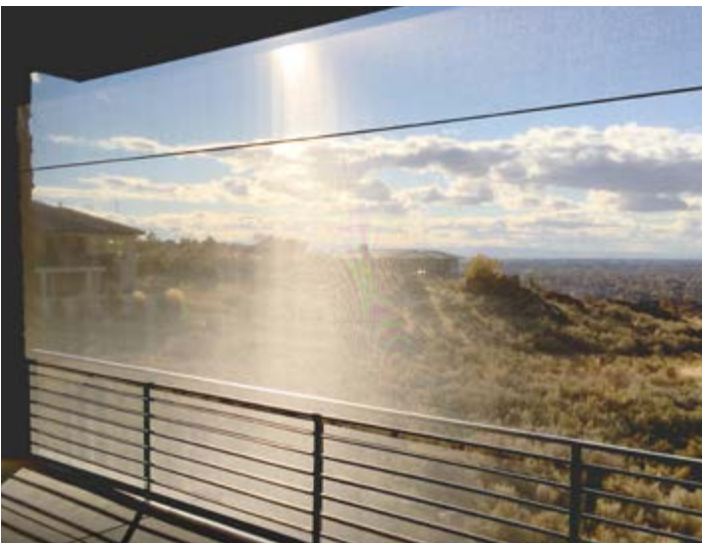

With the advantage of larger screen sizes, some solar screen fabrics with longer drops may require a horizontal seam.

Harbor with ShyZip® Tracks | Blind Appeal, Nampa ID

# HARBOR Exterior Solar Screen



**Harbor** is modeled after the industry's superior shading system, the Summit, and is exclusively manufactured and sold by Corradi USA. The base model is manual gear operated with detachable click-on crank, no side tracks, and a heavy duty bottom rail. The headbox has a curved front. Upgrade track options include the ShyZip® Spring fabric retention system or stainless steel cable guides for both manual or motorized. The manual option includes a detachable click-on crank with an inconspicuous foldable handle. The detachable crank can be used on a manual shade up to the manual maximum length of 16' wide. Motor configurations include a wired switch controlled motor or wireless remote controlled motor. Corradi offers the latest motors from Somfy® and other name brands. Any shade more than 16' wide must be motorized. Also, the wireless options can be used with a sun & wind sensor to automatically operate under specific conditions.

*\*Please note Harbor does not use mounting brackets.*

## IDEAL APPLICATIONS

**WINDOWS INSTALLED AS AN EXTERIOR APPLICATION**

**GARAGE DOOR OPENINGS, MAKING THE GARAGE A MULTI-USE AND INSECT FREE ROOM**

**PATIO COVERS TO CREATE INSECT PROOF SCREENED-IN PORCHES AT THE TOUCH OF A BUTTON**

**OUTDOOR RESTAURANT DINING AREAS**

**OUTDOOR SMOKING AREAS**

**RESIDENTIAL AND COMMERCIAL VERANDAS**

**LARGER WIDTHS AND OPENINGS**

## KEY DETAILS

**Max Width\*: 276"**

**Max Height\*\*: 192"**

\*Manual units can only be made up to a 16' (192") width.

\*Only Tuffscreen, Sheerweave 2000/2100, and Ferrari Soltis 88 can be used over a 18' (216") width.

\*\*Maximum width may be less for certain fabrics.

\*\*Maximum height for systems with vinyl window is 144" without special approval.

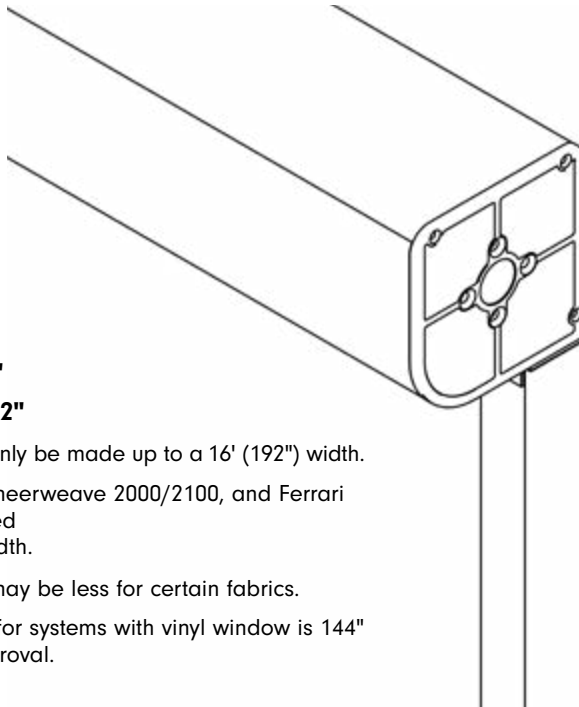

## FRAME COLORS

### POWDER COATING\*

The aluminum extrusions are painted with certified Qualicoat cycle epoxy powders.



WHITE QUARTZ



ANTHRACITE



CARBON



GLACIER



BEACH SAND



DUNE



GRANITE



CORTEN



URBAN BRONZE

\*RAL CUSTOM COLOR POWDER COATING IS ALSO AVAILABLE

Due to print variation these finish images should not be used for final production specifications.

## FABRICS

**Corradi USA offers a wide variety of fabrics for exterior solar screens. Listed below are standard and recommended fabrics available.**

### PHIFER

Solar protection fabrics with a wide range of openness

**SHEERWEAVE:**

2000, 2100, 2360, 2390,  
2410, 2500, 4000, 4100,  
and more...

**SUNTEX:**

80, 90, & 95

**TUFFSCREEN**

### SERGE FERRARI

Preconstraint tension vinyl and solar protection fabrics.

**SOLTIS PROOF W96**

**SOLTIS PROOF 502**  
**SOLTIS PERFORM 92**

**SOLTIS HORIZON 86**

**SOLTIS HARMONY 88**  
**SOLTIS OPAQUE B92**

### TEMPOTEST USA

Vibrant and durable injection dyed acrylic and solar protection fabrics.

**SOLID ACRYLICS**

**SOLID ACRYLICS FR**

### CLEAR VINYL WINDOWS WITH BORDERS

Protect from rain & keep the view. Clear vinyl windows include borders that can be constructed from vinyl coated textiles or acrylic fabrics.

### OTHER FABRICS APPLICABLE\*

These are fabric brands that may be used but are not standard:

Sunbrella Standard Acrylics

Sunbrella Premium Acrylics

\*Check with your authorized dealer for any other fabric options

## MOTORS

**SOMFY® 500 STARHEAD SERIES (MAESTRIA)**

(Override CMO not available.)



# Vista

Exterior Solar Screen

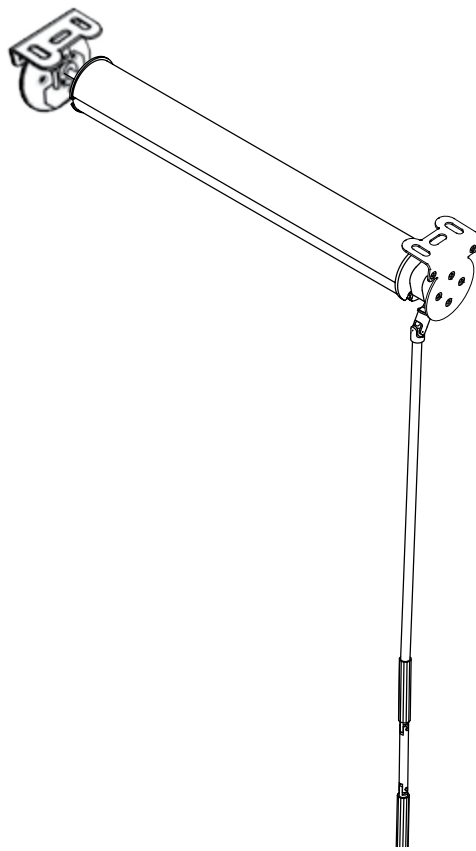

Extremely versatile, the Vista is Corradi's premier exterior open roll system with many options, including the ability to be installed in a pocket for inconspicuous operation.

Time to enlighten



Craft ideas

Vista with Cable Guides | Conroe Awning and Screen, Conroe TX

Vista Pocket Installation with embedded ShyZip® Tracks



# VISTA Exterior Solar Screen



**Vista** open roll system is exclusively manufactured and sold by Corradi USA. The base model is manual gear operated with detachable click-on crank, no side tracks, and a heavy duty bottom rail. Upgrade track options include the ShyZip® Spring fabric retention system or stainless steel cable guides for both manual or motorized. The manual option includes a detachable click-on crank with an inconspicuous foldable handle. The detachable crank can be used on a manual shade up to the manual maximum length of 16' wide. Motor configurations include a wired switch controlled motor or wireless remote controlled motor. Corradi offers the latest motors from Somfy® and other name brands. Any shade more than 16' wide must be motorized. Also, the wireless options can be used with a sun & wind sensor to automatically operate under specific conditions. The Vista is delivered ready to install with standard easy-to-use Vista brackets that can be used for either wall or ceiling mount.

## IDEAL APPLICATIONS

- WINDOWS, INSTALLED AS AN EXTERIOR APPLICATION.
- GARAGE DOOR OPENINGS, MAKING THE GARAGE A MULTI-USE ROOM
- RECESSED POCKETS
- PATIO COVERS
- OUTDOOR RESTAURANT DINING AREAS
- OUTDOOR SMOKING AREAS
- RESIDENTIAL AND COMMERCIAL VERANDAS

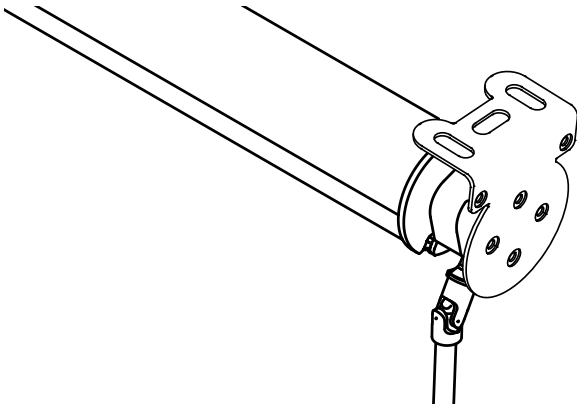

## KEY DETAILS

**Max Width\*: 276"**

**Max Height\*\*: 192"**

\*Manual units can only be made up to a 16' (192") width.

\*Only Tuffscreen, Sheerweave 2000/2100, and Ferrari Soltis 88 can be used over a 18' (216") width.

\*\*Maximum width may be less for certain fabrics.

\*\*Maximum height for systems with vinyl window is 144" without special approval.

## FRAME COLORS

### POWDER COATING\*

The aluminum extrusions are painted with certified Qualicoat cycle epoxy powders.



WHITE QUARTZ



ANTHRACITE



CARBON



GLACIER



BEACH SAND



DUNE



GRANITE



CORTEN



URBAN BRONZE

\*RAL CUSTOM COLOR POWDER COATING IS ALSO AVAILABLE

Due to print variation these finish images should not be used for final production specifications.

## FABRICS

Corradi USA offers a wide variety of fabrics for exterior solar screens. Listed below are standard and recommended fabrics available.

### PHIFER

Solar protection fabrics with a wide range of openness

<b>SHEERWEAVE:</b>	<b>SUNTEX:</b>	<b>TUFFSCREEN</b>
2000, 2100, 2360, 2390,	80, 90, & 95	
2410, 2500, 4000, 4100,		
and more...		

### SERGE FERRARI

Preconstraint tension vinyl and solar protection fabrics.

<b>SOLTIS PROOF W96</b>	<b>SOLTIS HORIZON 86</b>
<b>SOLTIS PROOF 502</b>	<b>SOLTIS HARMONY 88</b>
<b>SOLTIS PERFORM 92</b>	<b>SOLTIS OPAQUE B92</b>

### TEMPOTEST USA

Vibrant and durable injection dyed acrylic and solar protection fabrics.

**SOLID ACRYLICS**  
**SOLID ACRYLICS FR**

### CLEAR VINYL WINDOWS WITH BORDERS

Protect from rain & keep the view. Clear vinyl windows include borders that can be constructed from vinyl coated textiles or acrylic fabrics.

### OTHER FABRICS APPLICABLE\*

These are fabric brands that may be used but are not standard:

Sunbrella Standard Acrylics      Sunbrella Premium Acrylics

\*Check with your authorized dealer for any other fabric options

## MOTORS

**SOMFY® 500 STARHEAD SERIES (MAESTRIA)**

(Override CMO not available.)





# Horizon

360° Screen



Designed for 360° of interior and exterior skylight shading, as well as for mounting to existing structures for patio areas, the Horizon is a unique answer to controlling the sun's harsh U.V. rays.

Time to evolve



Horizon with custom powder coat frame | Pure Tech Window Fashion, Seattle WA



Balance and coordinate

The Horizon Frame may be only available in a white gloss finish, but many choose the upgrade of a custom powder coat frame finish to match their design.



Horizon with custom powder coat frame (3 left)  
Pure Tech Window Fashion, Seattle WA

# HORIZON 360° Exterior Solar Screen

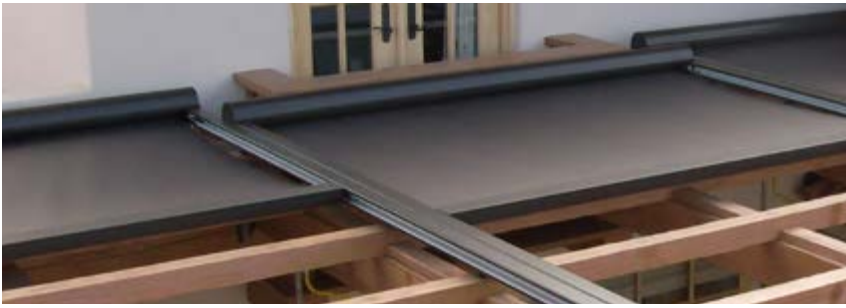

## FRAME COLORS

### POWDER COATING\*

The aluminum extrusions are painted with certified Qualicoat cycle epoxy powders.



WHITE GLOSS

\*RAL CUSTOM COLOR POWDER COATING IS ALSO AVAILABLE. (PICTURED ON THE LEFT)

Due to print variation these finish images should not be used for final production specifications.

**Horizon** is a shade structure unlike any other. It is capable of up to 195 square feet of coverage per individual unit. Even greater coverage can be created by installing the units side by side. Bottom-up applications are possible as well as any angle of application that offers a mounting surface. The Horizon can be mounted flush or up to a 2 foot distance from the mounting surface depending on the brackets you wish to use. The bracket options available for the Horizon are L-brackets for flush mounts or stand-off brackets for mounting above the surface (min 2"-max 24").

The base Horizon comes in white only, motorized, with tracks specifically engineered for the Horizon. The Horizon's constant tensioning design will give years of maintenance free sun control. Motorized only, the Horizon is available with several motor configurations including a wired switch controlled motor or wireless remote controlled motor. Corradi offers the latest motors Somfy® and other name brands. Wireless options can be used with a sun, wind, or a sun & wind sensor to automatically operate under specific conditions. All solar screen fabrics or solid awning fabrics are available for this system. The Horizon is designed only for sun control and is not intended to protect from rain. A unique characteristic of the Horizon system is that it can be paired with certain Corradi Pergotenda® models to create ultimate overhead control over the outdoor elements in complete style.

## SUMMARY

- RETRACTABLE CASSETTE SKYLIGHT DROP SCREEN/AWNING
- 360° MOUNTING RANGE AVAILABLE
- FLUSH (L-BRACKET) AND STAND-OFF MOUNT AVAILABLE
- MOTORIZED ONLY
- HORIZON SIDE TRACKS GUIDE OPTION ONLY
- STANDARD WHITE FRAME ONLY
- CUSTOM RAL POWDER COATING OPTION AVAILABLE

## SIZE RANGE

- Max Width**  
180" depending on drop
- Max Drop**  
180" depending on width
- Min Width**  
60"
- Min Drop**  
60"

## SIZE LIMITS

		WIDTH										
		5'	6'	7'	8'	9'	10'	11'	12'	13'	14'	15'
		60"	72"	84"	96"	108"	120"	132"	144"	156"	168"	180"
DROPP/ PROJECTION	5'	60"	YES	YES	YES	YES	YES	YES	YES	YES	YES	YES
	6'	72"	YES	YES	YES	YES	YES	YES	YES	YES	YES	YES
	7'	84"	YES	YES	YES	YES	YES	YES	YES	YES	YES	YES
	8'	96"	YES	YES	YES	YES	YES	YES	YES	YES	YES	YES
	9'	108"	YES	YES	YES	YES	YES	YES	YES	YES	YES	YES
	10'	120"	YES	YES	YES	YES	YES	YES	YES	YES	YES	YES
	11'	132"	---	YES	YES	YES	YES	YES	YES	YES	YES	YES
	12'	144"	---	YES	YES	YES	YES	YES	YES	YES	YES	YES
	13'	156"	---	---	YES	YES	YES	YES	YES	YES	YES	YES
	14'	168"	---	---	YES	YES	YES	YES	YES	YES	---	---
15'	180"	---	---	YES	YES	YES	YES	---	---	---	---	

## FABRICS

**Corradi USA offers a wide variety of fabrics for exterior solar screens. Listed below are standard and recommended fabrics available.**

### PHIFER

Solar protection fabrics with a wide range of openness

#### SHEERWEAVE:

2000, 2100, 2360, 2390, 2410, 2500, 4000, 4100, and more...

#### SUNTEX:

80, 90, & 95

#### TUFFSCREEN

#### SW PERFORMANCE PLUS:

2390, 2410, & 2500

### SERGE FERRARI

Precontraint tension vinyl and solar protection fabrics.

#### SOLTIS PROOF W96

SOLTIS PROOF 502

SOLTIS PERFORM 92

#### SOLTIS HORIZON 86

SOLTIS HARMONY 88

SOLTIS OPAQUE B92

### TEMPOTEST USA

Vibrant and durable injection dyed acrylic and solar protection fabrics.

#### SOLID ACRYLICS

SOLID ACRYLICS FR

### OTHER FABRICS APPLICABLE\*

These are fabric brands that may be used but are not standard:

Sunbrella Standard Acrylics

Sunbrella Premium Acrylics

\*Check with your authorized dealer for any other fabric options

## MOTORS

SOMFY 500 STARHEAD SERIES

## IDEAL APPLICATIONS

SKYLIGHTS

BOTTOM-UPS

ATRIUMS

SUNROOMS

ANY HORIZONTAL APPLICATIONS







# Shading Systems



Corradi USA Shading Systems are a collection of unique retractable systems specifically created for shade protection and diverse design.







# Shading Systems



Shan



Klip & Klip Pod

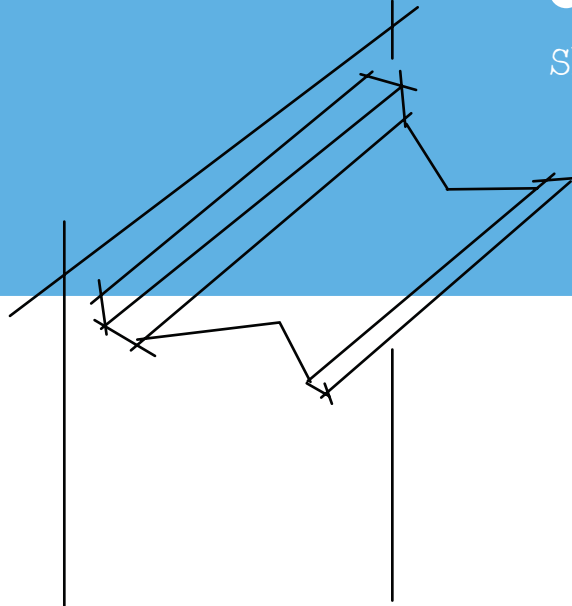

Shade and the art of  
optimizing it.

Sculpt the light and shadow of your outdoor space with Corradi's premiere Shading Line. The Art of Shading provides a variety of sophisticated retractable shading options that inspire and enhance any outdoor setting.



Svet

Feng

Frame

Defense

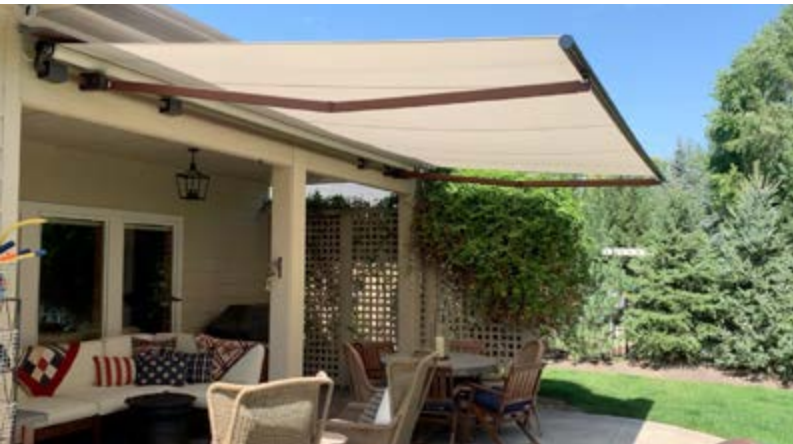

Svet | Blind Appeal, Nampa ID

From the sleek inconspicuous casing of the highly sought after Shan Awning to the nautical elegance of the Defense Shade Sail, Corradi Shading Systems are an essential presence in outdoor living and shading design.





# Shan

Retractable Awning  
by ShadeLab



Shan is a state-of-the-art fully enclosed box cassette awning. It works seamlessly, fully integrating with the architecture by following the aesthetic line.

Time to align





Seamless Integration





Shan Retractable Awning



Shan (2 above) | Pure Tech Window Fashion, Seattle WA

Shan (2 left) | Advanced Blinds & Awnings, Coeur d'Alene ID





# SHAN Retractable Awning



## FRAME COLORS

### POWDER COATING\*

The aluminum extrusions are painted with certified Qualicoat cycle epoxy powders.



\*RAL CUSTOM COLOR POWDER COATING IS ALSO AVAILABLE

**Shan** is a box cassette awning that is wall mount only because of its marked shape and design. It is always motorized. The D.T.S. system (Dynamic Tilting System) allows the tilting of the support when the awning is retracting, maintaining a perfect closure of the cassette. The special gasket along the length of the front bar makes the awning watertight and ensures silent closure. The compact box dimension is 10.16" in height and 7.28" deep. A single section is up to 23' (276") wide and can reach a 13'6" (162") projection. The Shan uses the patented feature arm Urban, the essence of the most advanced technology and fine Italian design. It features the innovative Dynamic Arm Torsion System, which helps to protect the traction mechanism and to prevent fabric tears. Pitch adjustment is available up to 40°. The micrometric regulation of pitch allows for easy and precise adjustment. The Shan is also motorized with a torque sensing motor with the limits preset at the factory. Standard Frame colors available for the Shan are White Quartz, Anthracite, & Corten—all finishes are matte. A complete line of awning fabrics are available, featuring our Para Tempotest line of 100% acrylic awning material. The Shan is a design patented system.

## FEATURES

**ACQUASTOP SYSTEM** The Aquastop gasket favours a perfect adherence of the cassette to the wall hence blocking the flowing of water in case of rain.

**DAT SYSTEM** (Dynamic Arm Torsion System) The distance between fabric and arm increases when deployed to protect the fabric.



**FULL CASSETTE AWNING** Retractable arm awning with fully enclosed cassette.

**MICROMETRIC REGULATION OF PITCH** Allows for easy and precise adjustment.

**MOTORIZED ONLY** The Shan uses a torque sensing motor.

**STAINLESS STEEL SCREWS AND PINS**

**URBAN ARM** The Urban arm is the essence of advanced technology and fine Italian design. No compromise on performances and details. An unprecedented retractable arm of unique design with raw materials of highest quality and the advanced technology of the DAT System come together to make the Urban arm a masterpiece in the world of shading.



**WIDE PITCH RANGE** Pitch ranges between 0° and 40°.

**WALL MOUNT ONLY** The Shan is installed mounted to a wall.  
(Roof mount may be available for approved applications.)

2010 RED DOT DESIGN AWARD WINNER

## WIDTH RANGE\*

DROP/ PROJECTION	WIDTH								
	10'	12'	14'	16'	18'	20'	21'	23'	
	120"	144"	168"	192"	216"	240"	252"	276"	
6' 6"	78"	YES	YES	YES	YES	YES	YES	YES	
8' 4"	100"	YES	YES	YES	YES	YES	YES	YES	
10'	120"	---	YES	YES	YES	YES	YES	YES	
11' 6"	138"	---	---	YES	YES	YES	YES	YES	
13' 6"	162"	---	---	---	YES	YES	YES	YES	

\*Maximum projection indicated is intended with arms at 0° pitch, perpendicular to the mounted wall. Increasing the pitch will decrease the projection when measured in a straight/perpendicular line from the mounted wall.

Configurations are a general guide for establishing minimum and maximum limits for what is possible to manufacture. Please consult with our pricebooks or customer service department for any technical inquiries.

## FABRICS

**Corradi USA offers the best in quality of acrylic fabrics for retractable awnings. Listed below are standard and recommended fabrics available.**

### PARA TEMPOTEST USA

Vibrant and durable injection dyed acrylic and solar protection fabrics.

**SOLID ACRYLICS**  
**SOLID ACRYLICS FR**  
**STRIPED ACRYLICS**

### OTHER FABRICS APPLICABLE

These are fabric brands that may be used but are not standard:  
Sunbrella Standard Acrylics  
Sunbrella Premium Acrylics

## MOTORS

**SOMFY® TORQUE SENSING RADIO MOTOR REQUIRED FOR SHAN.**  
(Override CMO not available.)



## PROJECTION & PITCH

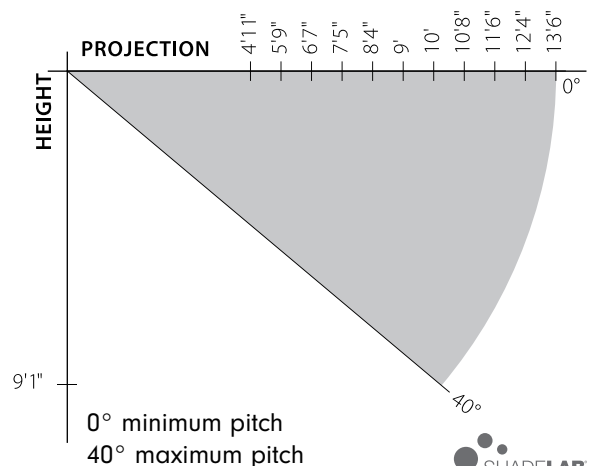







# Svet

Retractable Awning  
by ShadeLab



Extreme design, cutting edge performance and its distinct aluminum profile perfectly synchronizes the Svet with contemporary urban architecture.

Time to awaken





Expertise in ambiance

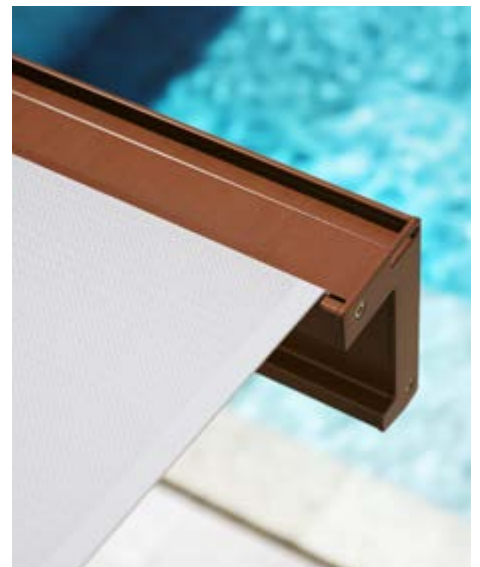

# SVET Retractable Awning



## FRAME COLORS

### POWDER COATING\*

The aluminum extrusions are painted with certified Qualicoat cycle epoxy powders.



\*RAL CUSTOM COLOR POWDER COATING IS ALSO AVAILABLE

**Svet** is particularly suited to shade the wide surfaces of bars, restaurants and resorts thanks to its new arm support in extruded aluminium that allows the Svet to reach a 23' (276") width by 13'6" (162") projection. The Svet uses the patented feature arm Urban, the essence of the most advanced technology and fine Italian design. Urban and Svet only use stainless steel hardware and the patented roller tube bracket seamlessly integrated with the square bar to eliminate the need for unsightly external bolted on brackets found in most other standard designs. It also features the innovative Dynamic Arm Torsion System, which helps to protect the traction mechanism and to prevent fabric tears. Standard Frame colors available for the Svet are White Quartz, Granite, Carbon & Corten—all finishes are matte. A complete line of awning fabrics is available, featuring our Para Tempotest line of 100% acrylic awning material. The Svet is patented in both technology and design.

## FEATURES

**DAT SYSTEM (Dynamic Arm Torsion System)** The distance between fabric and arm increases when deployed to protect the fabric.



### LED LIGHTING AVAILABLE

**MICROMETRIC REGULATION OF PITCH** Allows for easy and precise adjustment.

### MOTORIZED, AND CMO AVAILABLE

**HOOD OPTION** Protective Hood option is available to help protect fabric from the elements.

**OPEN ROLL AWNING** Retractable arm awning with exposed fabric roll.

### STAINLESS STEEL SCREWS AND PINS

**URBAN ARM** The Urban arm is the essence of advanced technology and fine Italian design. No compromise on performances and details. An unprecedented retractable arm of unique design with raw materials of highest quality and the advanced technology of the DAT System come together to make the Urban arm a masterpiece in the world of shading.



**WIDE PITCH RANGE** Pitch ranges between 3° and 60°.

**WALL & CEILING MOUNT OPTIONS** The Svet can be installed mounted to a wall or to a ceiling.

## WIDTH RANGE

DROP/ PROJECTION	WIDTH											
	10'	12'	14'	16'	18'	20'	21'	23'	24'	26'	28'	30'
6' 6"	78"	YES	YES	YES	YES	YES	YES	YES	YES	YES	YES	YES
8' 4"	100"	YES	YES	YES	YES	YES	YES	YES	YES	YES	YES	YES
10'	120"	---	---	YES	YES	YES	YES	YES	YES	YES	YES	YES
11' 6"	138"	---	---	YES	YES	YES	YES	YES	YES	---	YES	YES
13' 6"	162"	---	---	---	YES	YES	YES	---	YES	YES	---	---

\*Maximum projection indicated is intended with arms at 0° pitch, perpendicular to the mounted wall. Increasing the pitch will decrease the projection when measured in a straight/perpendicular line from the mounted wall.

Configurations are a general guide for establishing minimum and maximum limits for what is possible to manufacture. Please consult with our pricebooks or customer service department for any technical inquiries.

## FABRICS

**Corradi USA offers the best in quality of acrylic fabrics for retractable awnings. Listed below are standard and recommended fabrics available.**

### PARA TEMPOTEST USA

Vibrant and durable injection dyed acrylic and solar protection fabrics.

**SOLID ACRYLICS**  
**SOLID ACRYLICS FR**  
**STRIPED ACRYLICS**

### OTHER FABRICS APPLICABLE

These are fabric brands that may be used but are not standard:

Sunbrella Standard Acrylics  
Sunbrella Premium Acrylics

## MOTORS

**SOMFY® 500 STARHEAD SERIES**  
Override CMO is available

## LED LIGHTING (optional)

Only available for the front bar, as shown below



## PROJECTION & PITCH

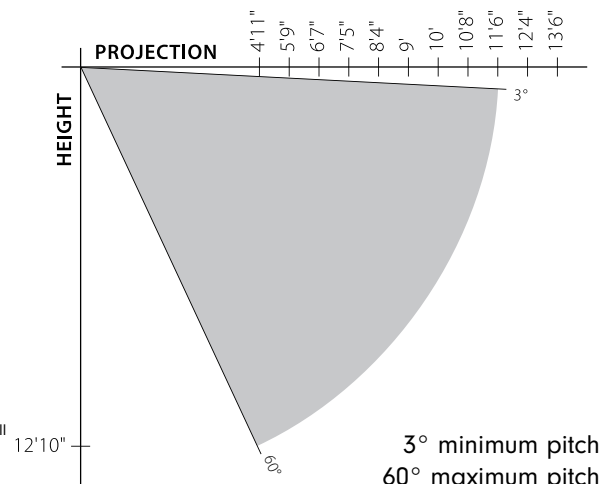

3° minimum pitch  
60° maximum pitch





# Klip & Klip Pod

Retractable Awning



The Klip and the Klip Pod (semi-cassette) are Corradi USA's classic and most versatile open-roll and semi-cassette awnings. Engineered to work flawlessly within an impressive range of sizes and options for both motorized and manual, the Klip and Klip Pod raise the bar for all awning design standards.

Time to enjoy



Aesthetic flexibility

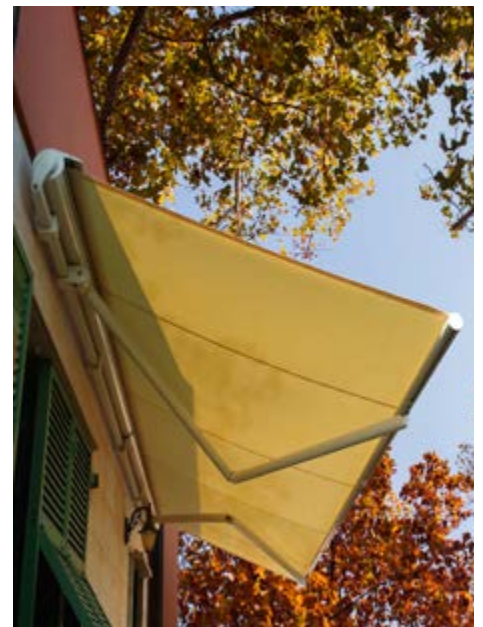

# KLIP & KLIP POD Retractable Awning



**Klip and Klip Pod** are elegant awnings made to size for protection from the sun. They are suitable to be installed on pre-existing structures either on the outside wall, beneath an eave, or on the roof. The Klip and Klip Pod awnings can be motorized with Somfy® and other name brands, or it can be made manual with gear spring assisted option for easy retraction. Wind and other types of sensors are available to help extend the life of motorized versions of these awnings. The arms are constructed with patented dual inline compression and tension springs, stainless steel strands PVC coated belt, and double sealed bearing elbow joints tested to 60,000 cycles. All of these components are made of powder coated aluminum and/or steel for an unobtrusive design concept. The Klip and the Klip Pod utilize the Klip arm bracket of which is a combination die-cast/extrusion to obtain the highest strength and still provide the maximum ease for pitch adjustment and installation. Thanks to the strength and the design of the arm bracket, the Klip and Klip Pod are the only awnings in the market that can safely go to a 11' 6" (138") projection still using a standard 40 x 40 mm square support bar. The Klip and Klip Pod's coverage ranges from minimum width of 9' to an impressive maximum width of 40'. Their awning arm projection range includes 4 sizes: 6' 6", 8', 10', 11' 6", and 13'.

## Klip (open roll)



## Klip Pod (semi-cassette)



## FRAME COLORS

### POWDER COATING\*

The aluminum extrusions are painted with certified Qualicoat cycle epoxy powders.



\*RAL CUSTOM COLOR POWDER COATING IS NOT AVAILABLE FOR EVO OR EVO SC. Due to print variation these finish images should not be used for final production specifications.

\*\*Corten is only available for the Klip Pod, NOT the Klip.

## FABRICS

**Corradi USA offers the best in quality of acrylic fabrics for retractable awnings. Listed below are standard and recommended fabrics available.**

### PARA TEMPOTEST USA

Vibrant and durable injection dyed acrylic and solar protection fabrics.

- SOLID ACRYLICS
- SOLID ACRYLICS FR
- STRIPED ACRYLICS

### OTHER FABRICS APPLICABLE

These are fabric brands that may be used but are not standard:

- Sunbrella Standard Acrylics
- Sunbrella Premium Acrylics

## MOTORS

SOMFY 500 STARHEAD SERIES

## FEATURES

- RETRACTABLE LATERAL ARM AWNING
- OPEN ROLL OR SEMI-CASSETTE (SC) AVAILABLE
- PITCH RANGES BETWEEN 5° AND 65°
- STRONG KLIP ARM BRACKET
- SUPPORTS UP TO 30' WIDTH COVERAGE (KLIP)
- WALL, CEILING OR ROOF MOUNT AVAILABLE
- HOOD AVAILABLE FOR THE OPEN ROLL
- MOTORIZED, MANUAL, AND CMO AVAILABLE

## PROJECTION & PITCH

PITCH RANGE FOR BOTH Klip & Klip Pod  
(Klip Pod PICTURED BELOW)

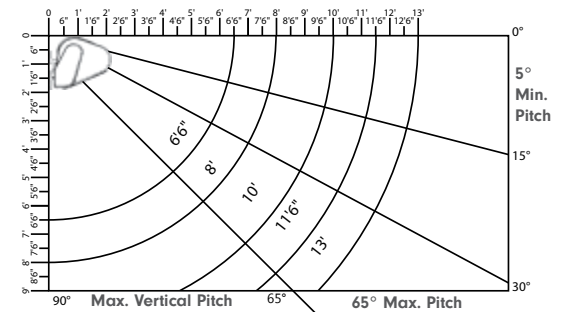

## WIDTH RANGE\*

		KLIP											
		WIDTH											
DROP / PROJECTION		10'	12'	14'	16'	18'	20'	21'	23'	24'	26'	28'	30'
				120"	144"	168"	192"	216"	240"	252"	276"	288"	312"
6' 6"	78"	YES	YES	YES	YES	YES	YES	YES	YES	YES	YES	YES	YES
8' 4"	100"	---	YES	YES	YES	YES	YES	YES	YES	YES	YES	YES	YES
10'	120"	---	---	YES	YES	YES	YES	YES	YES	YES	YES	YES	YES
11' 6"	138"	---	---	YES	YES	YES	YES	YES	YES	YES	---	YES	YES

		KLIP POD				
		WIDTH				
DROP / PROJECTION		10'	12'	14'	16'	17'9"
				120"	144"	168"
6' 6"	78"	YES	YES	YES	YES	YES
8' 4"	100"	YES	YES	YES	YES	YES
10'	120"	---	YES	YES	YES	YES
11' 6"	138"	---	---	YES	YES	YES

\*Maximum projection indicated is intended with arms at 0° pitch, perpendicular to the mounted wall. Increasing the pitch will decrease the projection when measured in a straight/perpendicular line from the mounted wall.

Configurations are a general guide for establishing minimum and maximum limits for what is possible to manufacture. Please consult with our pricebooks or customer service department for any technical inquiries.



# Feng

## Retractable Awning

by ShadeLab

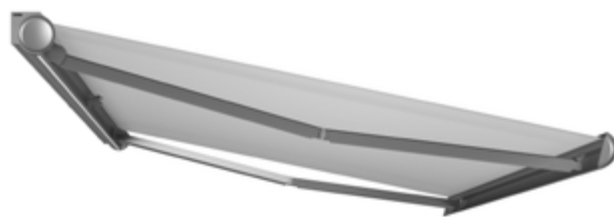

Distinctively round, Feng challenges design norms of the shading industry with its fully enclosed circular cassette.

Time to complete

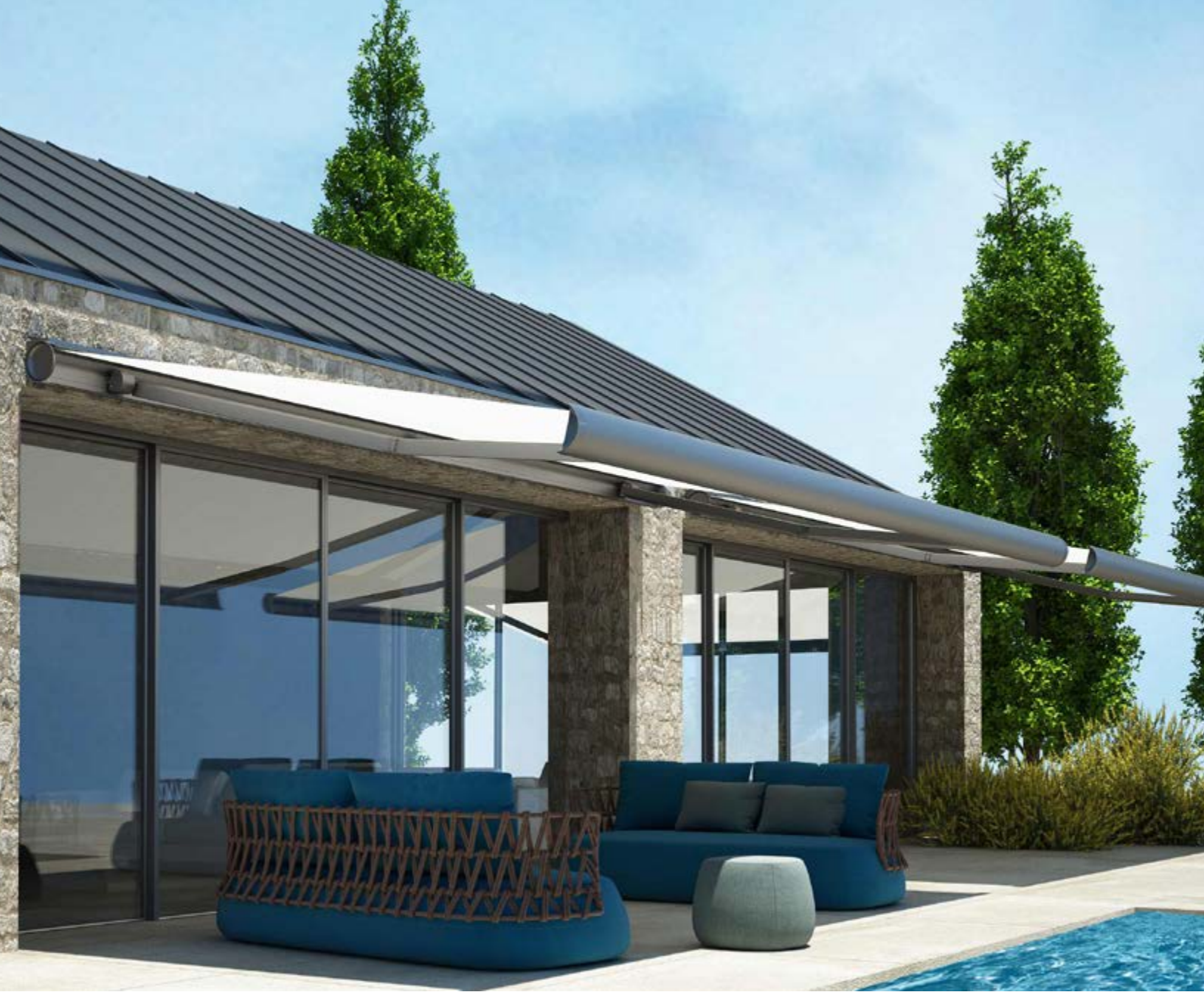

# FENG Retractable Awning



**Feng** creates spacious shade to enjoy moments of relaxation. With a max width of 23' (276") by 14' (168") projection and LED lighting options for the cassette or arms, Feng allows total flexibility in enjoying your outdoor space. Powder coat color options for the Feng include White Quartz, Granite, Carbon, and Corten – all finishes are matte. A complete line of awning fabrics is available, featuring our Para Tempotest fabrics made of 100% acrylic awning material.

## FEATURES

**DAT SYSTEM** (Dynamic Arm Torsion System) The distance between fabric and arm increases when deployed to protect the fabric.



**MICROMETRIC REGULATION OF PITCH** Allows for easy and precise adjustment.

**MOTORIZED, AND CMO (CONTROL MANUAL OVERRIDE) AVAILABLE**

**CASSETTE AWNING** Retractable arm awning with exposed fabric roll.

**STAINLESS STEEL SCREWS AND PINS**

**WIDE PITCH RANGE** Pitch ranges between 3° and 45°.

**WALL MOUNT** The Feng can only be installed mounted to a wall.

**OPTIONAL LED LIGHTING** The Feng has options for LED strip lights to the cassette or arms.

**URBAN ARM** The Urban arm is the essence of advanced technology and fine Italian design. No compromise on performances and details. An unprecedented retractable arm of unique design with raw materials of highest quality and the advanced technology of the DAT System come together to make the Urban arm a masterpiece in the world of shading.



## WIDTH RANGE\*

DROP/ PROJECTION	WIDTH							
	10'	12'	14'	16'	18'	20'	21'	23'
	120"	144"	168"	192"	216"	240"	252"	276"
6' 6" 78"	YES	YES	YES	YES	YES	YES	YES	YES
8' 4" 100"	---	YES	YES	YES	YES	YES	YES	YES
10' 120"	---	YES	YES	YES	YES	YES	YES	YES
11' 6" 138"	---	---	YES	YES	YES	YES	YES	YES

\*Maximum projection indicated is intended with arms at 0° pitch, perpendicular to the mounted wall. Increasing the pitch will decrease the projection when measured in a straight/perpendicular line from the mounted wall.

Configurations are a general guide for establishing minimum and maximum limits for what is possible to manufacture. Please consult with our pricebooks or customer service department for any technical inquiries.

## FRAME COLORS

### POWDER COATING\*

The aluminum extrusions are painted with certified Qualicoat cycle epoxy powders.



GRANITE



WHITE QUARTZ



CARBON



CORTEN

\*RAL CUSTOM COLOR POWDER COATING IS ALSO AVAILABLE

## FABRICS

**Corradi USA offers the best in quality of acrylic fabrics for retractable awnings. Listed below are standard and recommended fabrics available.**

### PARA TEMPOTEST USA

Vibrant and durable injection dyed acrylic and solar protection fabrics.

**SOLID ACRYLICS**  
**SOLID ACRYLICS FR**  
**STRIPED ACRYLICS**

### OTHER FABRICS APPLICABLE

These are fabric brands that may be used but are not standard:

Sunbrella Standard Acrylics  
Sunbrella Premium Acrylics

## MOTORS

**SOMFY® 500 STARHEAD SERIES**  
Override CMO is available

## LED LIGHTING (optional)



Cassette LED lighting shown above



Arm LED lighting shown above



## PROJECTION & PITCH

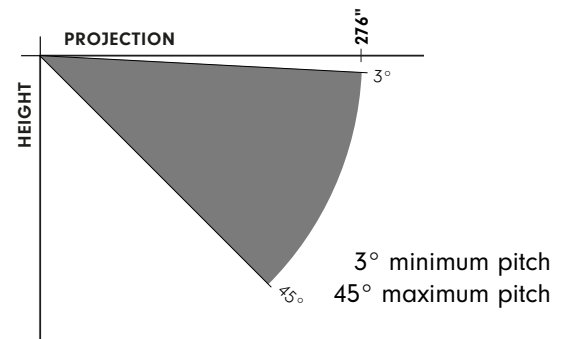









# Frame

## Retractable Awning

by ShadeLab



Frame blends with outdoor architecture in the most revolutionary and harmonious of ways. With shading fabric that traverses horizontally on rails rather than retracting arms, it is adaptable to countless diverse outdoor living spaces. This shading system is one of the most effective technological breakthroughs for outdoor shading.

Time to adapt



# FRAME Retractable Awning

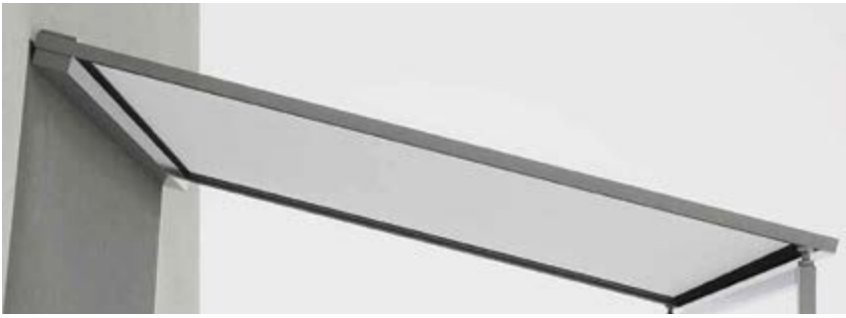

**Frame** is a horizontal shade with tensioned tracks instead of retracting arms. It is adaptable to shade patios, terraces, and windows.

A tensioning system with gas pistons, high-strength drive belt, and full cassette makes Frame the extraordinary piece that elevates an outdoor living space. The innovative front profile creates more stability in the Frame's design and gives Frame a unique and unmistakable look. If installed with ShyZip, Frame can be configured to reach dimensions up to 197" width x 197" length. If installed without ShyZip, maximum dimensions are 276" width x 276" length. Powder coating options for the structure include White Quartz, Granite, Carbon, and Corten.

## FEATURES

### MOTORIZED

**CASSETTE AWNING** Retractable track awning with fabric roll fully enclosed.

### STAINLESS STEEL SCREWS AND PINS

### SHYZIP GUIDES

### FRONT-SUPPORTING STAND

### TENSION GAS PISTON

**WIDE PITCH RANGE** Pitch ranges between 0° and 60°.

**WALL MOUNT** Frame can only be mounted to a wall. Not available as a freestanding unit.

## WIDTH RANGE\*\*

		WIDTH										
		6'7"	8'3"	9'11"	11'6"	13'2"	14'10"	16'5"	18'1"	19'9"	21'4"	23'
		79"	99"	119"	138"	158"	178"	197"	217"	237"	256"	276"
DROP/ PROJECTION	8'3" 99"	YES	YES	YES	YES	YES	YES	YES	YES	YES	YES	YES
	9'11" 119"	YES	YES	YES	YES	YES	YES	YES	YES	YES	YES	YES
	11'6" 138"	YES	YES	YES	YES	YES	YES	YES	YES	YES	YES	YES
	13'1" 158"	YES	YES	YES	YES	YES	YES	YES	YES	YES	YES	YES
	14'10" 178"	YES	YES	YES	YES	YES	YES	YES	YES	YES	YES	YES
	16'5" 197"	YES	YES	YES	YES	YES	YES	YES	YES	YES	YES	---
	18'1" 217"	YES	YES	YES	YES	YES	YES	YES	YES	YES	---	---
	19'9" 237"	YES	YES	YES	YES	YES	YES	YES	YES	YES	---	---
	21'4" 256"	YES	YES	YES	YES	YES	YES	YES	---	---	---	---
	23' 276"	YES	YES	YES	YES	YES	YES	YES	---	---	---	---

**TEMPOTEST ACRYLIC FABRICS** Max width recommended is 14'10"

**SHYZIP DIMENSIONS** Max width is 16'5"

\*\* Maximum projection indicated is intended with arms at 0° pitch, perpendicular to the mounted wall. Increasing the pitch will decrease the projection when measured in a straight/perpendicular line from the mounted wall.

Configurations are a general guide for establishing minimum and maximum limits for what is possible to manufacture. Please consult with our pricebooks or customer service department for any technical inquiries.

## FRAME COLORS

### POWDER COATING\*

The aluminum extrusions are painted with certified Qualicoat cycle epoxy powders.



GRANITE



WHITE QUARTZ



CARBON



CORTEN

\*RAL CUSTOM COLOR POWDER COATING IS ALSO AVAILABLE

## FABRICS

**Corradi USA offers the best in quality of acrylic fabrics for retractable awnings. Listed below are standard and recommended fabrics available.**

### PARA TEMPOTEST USA

Vibrant and durable injection dyed acrylic and solar protection fabrics.

**SOLID ACRYLICS**  
**SOLID ACRYLICS FR**  
**STRIPED ACRYLICS**

### OTHER FABRICS APPLICABLE

These are fabric brands that may be used but are not standard:

Sunbrella Standard Acrylics  
Sunbrella Premium Acrylics

## MOTORS

### SOMFY® 500 STARHEAD SERIES

Override CMO (control manual override) is available

## PROJECTION & PITCH

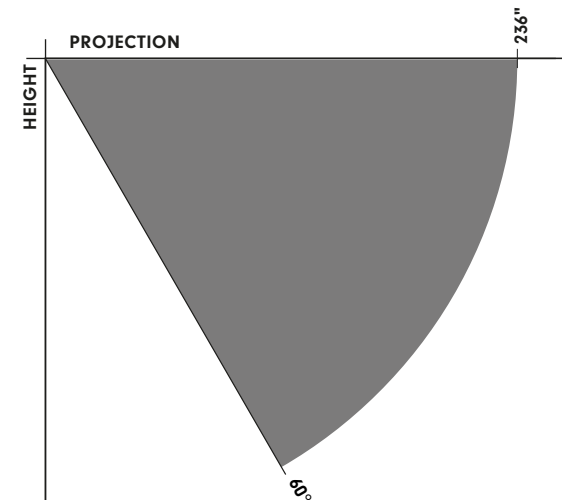

### Without Shyzip

0° minimum pitch  
60° maximum pitch

### With Shyzip

15° minimum pitch  
25° maximum pitch  
197" maximum projection



# Defense

## Shade Sail



The Defense Shade Sail stems from a deep knowledge of the nautical world. The application of technology and materials that are primarily used at sea makes the Defense completely unique and provides excellent resistance to weathering, salinity and wear.

Time to embark



Be free



# DEFENSE Shade Sail



**Defense Shade Sail** is in a class of its own. A Free Standing shade made of stainless steel frame and white Dacron canvas sail that may be rotated up to 360°. It is motorized only and the Dacron canvas quickly winds up by using a remote-control. It is also fitted with an anemometer for automatically closing the sail in the event of strong wind. The self-supporting shade structure is composed of two white Dacron winding sails on a horizontal mast attached to a curved frame. The sails are also connected to stainless steel supporting arms and tensioned by high tenacity Dyneema ropes. A stainless steel cleaning kit is supplied as standard.

\*The sail cover should be considered optional in winter for products that remain exposed outdoors.

Above Defense Image courtesy of Outdoor Living Solutions, London Ontario, Canada

## Defense has 3 mount/standing options:

Anchored to the ground is the standard solution (anchors not supplied), counter plate with prongs embedded in concrete plinth, or ballasted base with optional stainless steel cover. (Ballast blocks not supplied.)

PLEASE NOTE WHEN INSTALLING ON BALCONY/TERRACE: Check load capacity of the balcony/terrace on which the chosen structure is to be installed.

### GROUND POLE

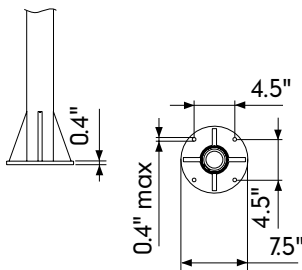

### IN-GROUND COUNTER PLATE

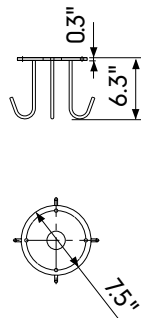

### BALLASTED BASE

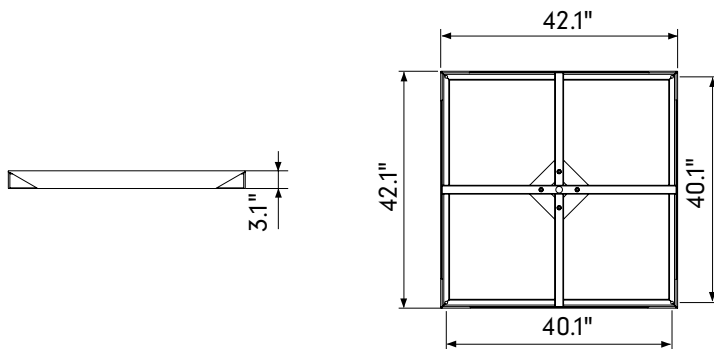

### FRAME



STAINLESS STEEL ONLY

### FABRIC



DACRON CANVAS  
WHITE ONLY

Due to print variation these finish images should not be used for final production specifications.

### MOTORS

SOMFY 535 CMO (MOTOR OVERRIDE) ONLY

EOLIS RTS SENSOR KIT ANEMOMETER

(MOTOR CONNECTED WIND SENSOR)

### FEATURES

FREESTANDING SHADE SAIL

NAUTICAL DESIGN TECHNOLOGY & COMPONENTS

3 MOUNT/STANDING OPTIONS AVAILABLE

360° ROTATION

RESISTS SALINITY AND ATMOSPHERIC EVENTS

LOW MAINTENANCE

BRUSHED/POLISHED STAINLESS STEEL FINISH

STAINLESS STEEL CLEANING KIT PROVIDED

### DETAILED DEFENSE MEASUREMENTS

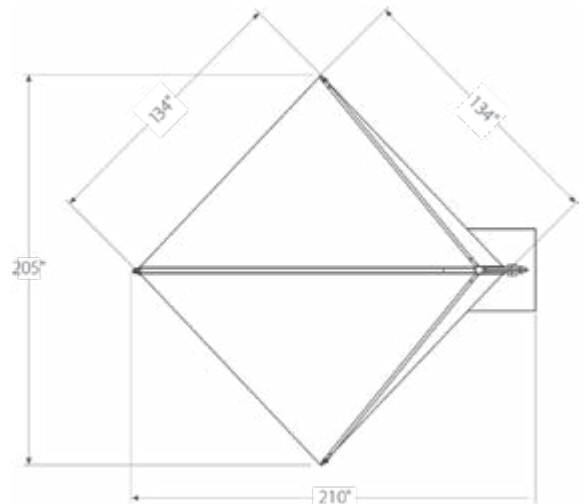





# Fabrics

## Corradi USA Fabric Collection



From the simplest insect screen to the most luxurious fabric, Corradi offers a vast array of fabrics from the most reputable manufacturers in the outdoor industry: Tempotest® USA, Phifer®, and Serge Ferrari® among others.\*

A selection of over 300 colors, styles and textures to choose from to personalize your Corradi system depending on your needs—whether strictly technical, aesthetic or anywhere in between.

Time to weave

*\*Please Contact your Authorized Corradi USA Dealer for fabric samples.*

# FABRIC COLLECTION Phifer® Solar Fabrics



Phifer® is the world's leading manufacturer of energy-saving sun control fabrics for both the residential and commercial markets. The Corradi USA collection of Phifer products includes SheerWeave®, SunTex® 80/90/95, TuffScreen® and Super Solar Screen+ for use in our exterior screen and solar protection applications.



**SheerWeave®** sun control fabrics provide the perfect balance of light, comfort and beauty, making them the ideal window covering solution for residential and commercial spaces alike. SheerWeave filters and diffuses light while reducing glare and solar heat gain, conserving energy and helping to create a more comfortable environment. SheerWeave also helps reduce the fading of interior furnishings and flooring by protecting these surfaces from the sun's harmful effects. And unlike many window treatments, SheerWeave allows excellent outward visibility—even when shades are lowered—to maintain optimal views.



**SunTex® 80,90,95.** Our most popular exterior fabric, SunTex sun shading material, is made of strong vinyl-coated polyester in 80%, 90% and 95% sun blocking options and up to ten color choices. SunTex® is ideal fabric for use in our retractable exterior solar screens for window shades and enclosures.

**TuffScreen** is a durable, vinyl-coated polyester insect screening that resists tears, punctures and damage from pets and high traffic areas. Featuring width options up to 132", TuffScreen is the perfect choice for use in expanded view openings such as porch, patio or lanai enclosures.



Phifer manufactures the only Sun Control fabrics in the world to include Microban protection. Microban antimicrobial protection works continuously to inhibit the growth of bacteria, mold and mildew that can cause stains, odors and product deterioration. Microban antimicrobial protection is infused into all Phifer Sun Control fabrics for lasting protection that won't wash off or wear away for the lifetime of the shade. Microban is the leading technology in antibacterial/antifungal protection.



GREENGUARD Certification ensures products have met some of the world's most rigorous and comprehensive standards for low emissions of volatile organic compounds (VOCs) into indoor air.



Sun Control fabrics are flame retardant and meet certain flame certification standards based on national and local requirements. Check the flame certification standards requirements for your project to verify compliance.



Phifer's broad range of Sun Control fabrics provide excellent reduction in solar heat gain for a more comfortable environment and less work for your air conditioner. Allowing diffused natural light in, Sun Control fabrics may also reduce the need for additional interior lighting for added savings.



Printing unique colors, patterns, logos and graphics on Sun Control fabrics opens a whole new opportunity for product applications. Sun Control fabrics are ideal for digital and screen printing methods. Your local printer can recommend the best print options based on their capabilities.



Phifer Incorporated's entire line of Sun Control fabrics are lead free, meeting and far exceeding several window covering industry testing standards for hazardous materials. Sun Control products comply with RoHS/Directive 2002/95/EC, the US Consumer Product Safety Commission Section 101 and ANSI/WCMA A100.1-2007 for lead content. According to the Environmental Protection Agency, certain levels of exposure to lead, which can be found in everything from painted toys and furniture to soil around a home, can result in a variety of health effects. Even low levels of exposure can be harmful to children. The lead-free stamp marks another confirmation of Phifer's commitment to remain environmentally responsible.



The Melanoma International Foundation (MIF) is an organization established in 2003 to provide sound guidance and support by a Scientific Advisory Board of credentialed medical professionals and melanoma specialists. MIF provides free screenings and educational opportunities to communities nationwide. Phifer Sun Control fabrics have been independently tested for their effectiveness in preventing sun damage to the skin and eyes as required by MIF standards. The MIF seal of approval is awarded to manufacturers of fabrics that demonstrate high performance in traditional shading devices such as umbrellas, awnings, sun shades, and other complimentary sun protective products including sunscreen lotion and sun protective clothing.



Serge Ferrari has been creating innovative products that offer high added value for its customers since 1973. This constant quest for excellence means that today, they have mastered all the technologies involved in the production of effective, high quality, flexible composite materials.

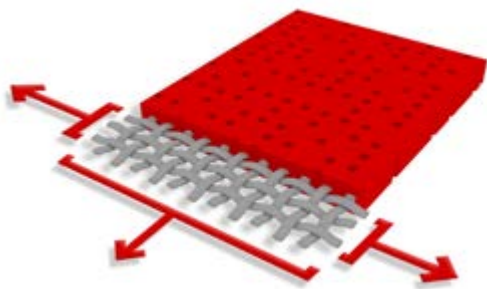

### Exclusive Serge Ferrari Précontraint® Technology

Précontraint technology, protected by a worldwide patent, enables the production of flexible composite materials with exceptional dimensional properties, way above the industry's usual standards. Précontraint technology consists in applying a coating under bi-axial tension (along both the warp and the weft) throughout the manufacturing cycle: the flexible frame made from high tenacity PET micro-cables is coated with several layers of polymers, followed by a dirt resistant surface treatment. The materials using Précontraint technology thus acquire unique properties in terms of resistance, dimensional stability and light weight, eliminating deformation due to load and offering a longer useful life.

## So Soltis® Fabrics

A wide range of options are available to meet every shading and cooling need, from view-thru to privacy, waterproof to airflow, and light filtration to blackout. Soltis mesh fabrics may be used both indoors or out (ShyZip® screens, tensile shades, Pergotenda® retractable roof fabrics) for easy coordination. Awning and Pergotenda® covers may be smooth and colorful, or in neutral colors with a natural effect. And, no matter the application, Soltis fabrics are built to last, providing excellent UV, water, mold, and fading resistance, so they look as beautiful in future years as they do today.

**Soltis Proof 502** (previously named Précontraint® 502 Satin) is a highly durable, dimensionally stable material with a 10 year warranty. This waterproof material protects against bad weather and UV and offers exceptional dirt and mold resistance due to its PVDF surface treatment. Available in 40 colors and with an attractive satin finish, Soltis Proof 502 is ideal for translucent screen material, borders for clear vinyl windows, and Corradi Pergotenda® retractable roof material. This fabric is recyclable.

**Soltis Horizon 86** is a Précontraint® fabric with 14% open mesh that offers the best outward visibility. It has a transmission of up to 28% natural light that is very beneficial to occupant well-being. This fabric is GreenGuard certified and recyclable.

**Soltis Proof W96** is a Précontraint® fabric that protects against UV rays and bad weather, while preserving the level of natural light transmitted. This textured translucent, waterproof fabric is ideal for Corradi Pergotenda® retractable roof material. This fabric is recyclable.

**Soltis Harmony 88** is an 8% open mesh Précontraint® fabric and offers a perfect balance between design, transparency and thermal comfort. This micro-perforated screen has a regular weave, making it ideal for Corradi Exterior Solar Screens. This fabric is GreenGuard certified and recyclable.

**Soltis Perform 92** is a 4% Précontraint® open mesh and an effective thermal shield. It blocks up to 97% of heat in external window applications. Available in 48 colors, this micro-perforated screen offers the best thermal performance while maintaining outward visibility. This fabric is GreenGuard certified and recyclable.

**Soltis Opaque B92** is a Précontraint® fabric that enables total darkness, blocking 100% of UV, heat and light. This opaque / privacy fabric is suitable for both indoor and outdoor use. This fabric is GreenGuard certified and Recyclable.



GREENGUARD Certification ensures products have met some of the world's most rigorous and comprehensive standards for low emissions of volatile organic compounds (VOCs) into indoor air.



All of the above fabrics are recyclable. This is a quantified response to combat depletion of natural resources

# FABRIC COLLECTION Para Tempotest® USA Acrylic Awning Fabrics



**Color and style tell your story to the world.** Tempotest® provides you the widest color and pattern selection so your story is uniquely you. Our palate is your playground. For a serene and tranquil setting, explore our blue hues. Feeling confident, bold and passionate? Red is your color choice. Playful orange and yellow evoke happiness, creativity and warmth. Tempotest allows you to express your own colorful personality. **Whatever your story, Tempotest can help you tell it.**

Corradi USA's #1 fabric choice for Awnings, Tempotest® USA has a stunning selection of solid color acrylic fabrics applicable for awnings, clear vinyl window borders or full exterior screen coverage. These fabrics are created for outdoor living solar protection and custom style.

Tempotest® fabrics integrate perfectly in any outdoor space creating a protection from the sun's UV rays, as well as adding a touch of color and elegance. Tempotest® is the leading acrylic awning fabric collection with the most comprehensive assortment of color options for screens and awnings—including both striped and solid colors—designed to fit any lifestyle.

The quality of the solution dyed fiber and the innovative finishing Teflon® Extreme by Parà® fabric protector, make Tempotest® fabrics water/oil repellent, resistant to mold, stains, salt and U.V. fading.

Important collaborations with companies of the highest level has led to the creation of special and exclusive products that Parà® uses to reach the highest goals.

- Most comprehensive collection of stylish colors
- Protection from the sun's harsh UV rays
- Long term strength and durability
- Fade resistant solution dyed fiber
- Teflon® Extreme fabric coating protection
- Easy maintenance
- Certified by the highly respected authorities



[www.tempotestusa.com](http://www.tempotestusa.com)

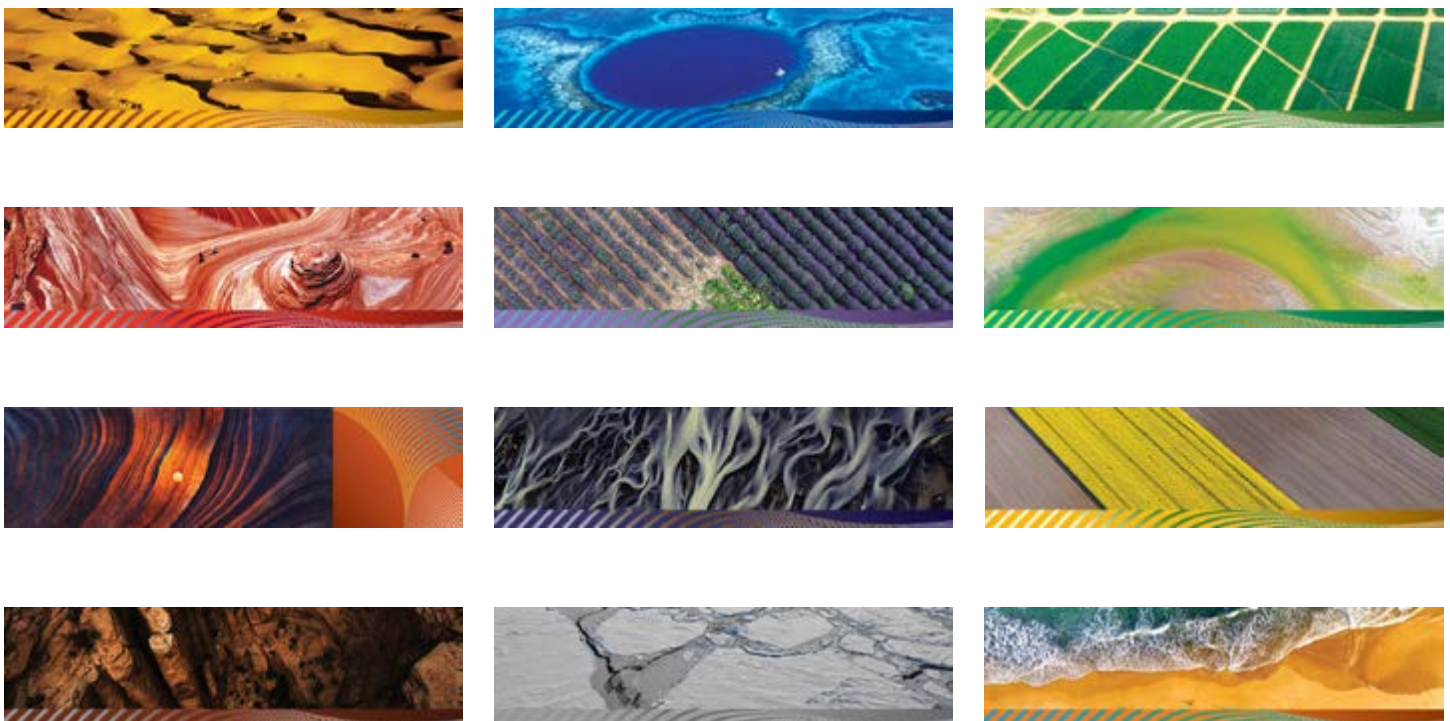



# FABRIC COLLECTION **Clear Vinyl Window Option**

Clear Vinyl Windows allow you to enjoy your outdoor views while easily protecting and managing your surrounding environment from undesired weather, fluctuating temperatures, and irritating bugs.

Experience a more brilliant atmosphere with adjustable, energy efficient clear vinyl windows. These specialty windows when rolled down can resist hot and cold temperatures, deter unwanted bugs, and eliminate the worry of inclement weather. Exceptional quality double polished clear vinyl presents a sleek and lustrous crystal clear finish that when used with the various options of Corradi USA Exterior Shade Systems, creates unique control over outdoor spaces extend the enjoyment of your surroundings.

\*All Clear Vinyl is not covered by warranty.

- IDEAL APPLICATIONS:**
- OUTDOOR SPACES WITH A GREAT VIEW AND UNPREDICTABLE WEATHER**
- WIND & VAPOR BARRIERS**
- INSULATION**
- INSECT CONTROL**
- NOISE REDUCTION**
- AVAILABLE FOR STRATUS, SUMMIT, HARBOR AND VISTA EXTERIOR SCREEN SYSTEMS ONLY**

Clear vinyl window Harbors, white vinyl border, with ShyZip® Tracks | Awnings & Signs by Pomfret, Cumberland RI



Clear vinyl window Harbors, black vinyl border, with ShyZip® Tracks (2) | Total Shade, Frisco TX

# FABRIC COLLECTION Eclissi Blackout Fabric with Radiant Barrier

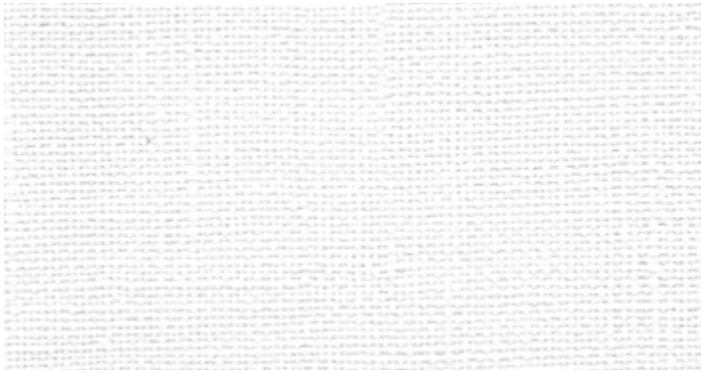

ECLISSI WHITE\*



ECLISSI IVORY\*



ECLISSI GREY\*



Pergotenda® Palladia® with white Eclissi | New Haven Awning, New Haven CT

Corradi Eclissi Technical information

## TPOLOGY

High tenacity 1100 Dtex Polyester base fabric with PVC coating.

## FEATURES

850 gr/m<sup>2</sup> for longer duration. Blockout thanks to black internal double coating. The embossed finishing on the inner side gives a textile appearance and a dynamic effect on the surface. Outer side anti-dust acrylic lacquered. Two different tones on outer and inner side allow colour matching of with surrounding structures while champagne/white inner side gives brighter room under the structure. Flame retardant according to Italian CL.2, German B1 and French M2 standards.

5-year warranty.

**Colors Available:** White, Ivory, Grey

**Yarn:** Warp—polyester 1100 Dtex / Weft—polyester 1100 Dtex

**Thickness:** 0.50 mm

**Weight** (ISO 2286-2): ca 850 g/m<sup>2</sup>

**Flammability:** M2

**Finish:** Outer side—matte PU lacquered / Inner side—matte lacquered with embossing, waterproof.

**Breaking strength** (ISO 1421) Warp—ca 250 DaN/5 cm / Weft—ca 250 DaN/5 cm

**Tear strength** (DIN 53363): warp: ca 25 DaN / weft: ca 20 DaN

**Light Fastness** (DIN 53388): level 7/8

**Temperature resistance:** +70°C / -30°C

**Adhesion** (ISO 2411): ca 10 DaN/5 cm

**Roll width:** 300 cm

**Roll length:** ca 60 m (standard) / ca 250 m (upon request)

COLLECTION 2013/2016 the a. m. technical data can vary according to production lots and are subject to a ±5% tolerance.

COLOR	GTOT external	GTOT internal
WHITE	0.02	0.33
IVORY	0.03	0.36
GREY	0.05	0.44

These values are indicative; They are provided for information purposes to ensure the best use of the product. They may be subject to change in line with advances in technology, the type of use of the material and the geographical location of the installation.

*\*Due to print variation, printed images of this fabric should **not** be used for final production specifications.*

## FABRIC COLLECTION **Dacron Shade Sail Fabric**

Used on Defense Shade Sail only

White color available only

Fabric weight 11oz. per sq. yd.

100% polyester

Anti-UV finishing



# Motorization

## Corradi USA Motor options



Motorization of outdoor living systems opens up a whole new world of control over your outdoor living space.

Here at Corradi USA we use primarily Somfy® motorization, which also allows for Sun, Wind and Rain sensor options as well as for the ability to be connected to Somfy's home automation system. The ease and convenience of operating your system via motorization will make your outdoor living area work like a dream.

Time to empower



Whether you want to control your exterior screens and solar shades at the touch of a button or use automatic controls, Somfy® has the solution for all of your motorization needs.

Somfy®, the world’s leading manufacturer of tubular motors, has more than four decades of experience in designing and manufacturing motors and controls, making **Radio Technology Somfy® (RTS)** the ultimate choice for the automation of exterior screens and solar shades. Radio Technology Somfy® (RTS) offers a high performing, reliable solution for exterior screen and solar shade motorization. Since the radio receiver is integrated within the motor, making RTS the ideal choice for hassle-free installation and quick and easy operation.



## SENSORS



### Sunis RTS Sensor Kit

This battery-operated, outdoor sensor automatically adjusts Somfy® powered exterior products based on the sun’s intensity.

### Eolis RTS Sensor Kit

The Eolis 3D WireFree™ RTS Wind Sensor is a wireless, battery powered wind sensor that will automatically retract an awning based on wind generated movements.

### Soliris RTS Sensor Kit

The Soliris RTS Sun and Wind Sensor automatically controls your RTS motorized products based on current weather conditions.

## TIMER



### Chronis RTS Timer

The Telis 1 Chronis RTS combines the functionality of a single channel hand-held control with the convenience of a programmable timer. This control option is compatible with all motorized Radio Technology Somfy® applications and offers simple programming and easy operation.

## AUTOMATION CONNECTIVITY



### TaHoma Smart Phone Interface

The Somfy® Tahoma™ is a simple device that turns your smartphone or tablet into a sophisticated remote control for motorized products featuring Radio Technology Somfy®. Tahoma now works with Alexa, IFTTT and Google Home!

## CONTROLS



### Telis RTS Remote

The Telis RTS is a convenient hand-held remote for use with any motorized product featuring Radio Technology Somfy®. It's available in a variety of colors and channels. **Available in 1 channel, 5 channel (Situo Remote), and 16 channel.**

### Soliris 1 Channel Remote

The Telis Soliris RTS is a hand-held remote to operate awnings, screens and shutters featuring Radio Technology Somfy®. It also has the added feature of activating an RTS sun sensor remotely.

### Decoflex Wall Switch Remote

The DecoFlex WireFree™ RTS is battery-powered and a completely wireless wall switch that provides an ideal way to control motorized products when entering or exiting a room. It's compatible with all Radio Technology Somfy® motorized products and is available in a variety of colors and channels.

## MOTOR CORDS

Somfy® offers many options for motor cords, including RTS vs Standard and plug vs no plug. The Standard Cord length for Somfy® Motors is 10' **without a plug**. Optional sizes may range from 12', 18' to 24'.

# Maestria 50 RTS by somfy.

## Motorization for external vertical screens in RTS technology.

Somfy® Maestria motors are used for Corradi USA Exterior Screens. They are available RTS (radio/remote controlled) or standard wired with a switch. Sun, wind, and rain sensors are also available along with Home automation compatibility.

### Designed to meet your project needs.

Somfy's flexible motor designs meet the needs for many shading or window control applications. These motors offered in various sizes and technology options can be used on projects of all shapes and sizes. Somfy® motors are available in a wide range of drive and crown sizes to support different tube diameters and window sizes. With ultra-quiet operation and a wide torque range, Somfy® motors are also offered in a wide range of supply voltages offering specific power solutions for retrofit or new construction projects.

#### Intelligent

Smart functions such as obstacle detection\* and automatic adjustment protect carrier products, prevent fabric damage and assure perfect tension.

#### Reliable

Obstacle detection\* protects the fabric, minimizes service calls and costly on-site support, offering peace of mind for everyone.

#### Flexible

Compatibility with all types of screens and control options make it a perfect all-in-one solution for exterior screens.

#### Easy to Install

Plug & Play and precise setting features make installation quick, easy and streamlined.

\*Obstacle detection feature is only available when ShyZip® tracks are also utilized.

---

\*Check with your Authorized Corradi USA Dealer about other motor brands that may be available upon request.

---

## COMPARISON Motor vs Manual

Operating exterior shading systems with a motor and adding automation features such as a Sun Sensor, Wind Sensor or even integrating the Shade Motor with a home automation protocol is extremely common and has been an option for several decades. A motor is simply one of the most reliable components of a screen system. The fact the technology has been in use for over thirty years and has only become more reliable is justification for adding a motor to your exterior screen.

### WHY MOTORIZED?

**SIMPLIFIED, EASY OPERATION** Push button operation by remote control or wireless wall switch.

**ACCESS** On a high exterior window, motorization may be the only method to operate the screen. Or, a very tall or exceptionally large screen, motorization may be the only method of effective operation.

**VALUE** When screens are motorized, they are actually used more often because they are so easy to operate.

**EFFICIENCY** Rather than manually operating each screen, motorized screens are easy and quick to operate, especially with two or more exterior screen systems.

**AUTOMATION** Sensors to provide for optimum solar protection can be added to automatically operate the screens when the sun becomes visible.

**LIFESTYLE** More and more features in homes and buildings are automated.

**PRICE** The cost of adding a motorized solution to your exterior screen is not a significant cost in terms of the overall cost of the screen and high quality solar protection fabrics.

**RELIABILITY** The motors offered today have the latest technology that has been developing for over 30 years in Europe. The functionality and warranties offered today make this an easy purchasing decision.

**ECO-FRIENDLY** More and more systems and features are becoming available with solar powered options.

### WHY MANUAL?

**BUDGET** While motorized screen prices continue to head downward, a manually operated screen can still save you money. This is a no frills, least expensive method to add solar and insect protection to your outdoor environment.

**NO ELECTRICITY AVAILABLE** to allow for a motorized screen.

**ECO-FRIENDLY** No electricity used is not necessarily a bad thing.

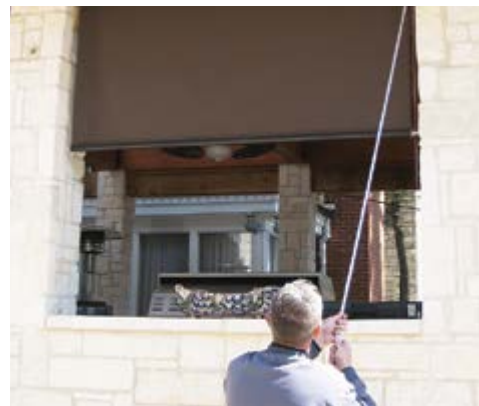

## MOTORIZATION Pergotenda® Motors\*

\*Pergotenda® systems are only available Motorized.

The Corradi Pergotenda® motor system and software associated with it are unique and innovative. What sets Corradi's motor system apart from any other in the industry are these two exclusive key features—utilization of proprietary software to operate and control the motor, and the incorporation of a shaft driven motor.

The innovative software, developed by Corradi Italy several years ago, grants seamless control of the retractable roof canopy with the touch of a single button. The controls also enable precise positioning of the roof canopy anywhere along the rails, not only fully retracted or deployed. This software furthermore allows for integration of third-party controls such as building automation or fire suppression software.

The shaft-driven motor is unique in comparison to any other motor system on the market. Other motor systems use a tubular motor that requires a secondary apparatus to operate the roof canopy. Tubular motors are prone to excessive overheating as the thermal overload on a tubular motor will kick in 2-3 time faster than the Corradi shaft motor. Also, the inherent limitation with a tubular motors is the general ability to operate only up to a 20' maximum projection whereas Corradi's shaft-driven motor is easily operational up to a 30' maximum projection. Finally, the best attribute of the Corradi shaft-driven motor is that it will deploy a roof canopy on average 30% faster than the competition.

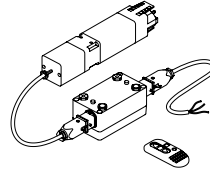

### ELECTRIC DRIVE TYPE 2

110 volt motor reducer with encoder and microchip that controls the canvas tension, guarantees constant correct tension despite size variations caused by temperature changes, with radio-control and 1 channel transmitter. Pulls 2 amps. Required for 2 or 3 runners Pergotenda®.

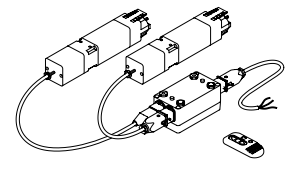

### ELECTRIC DRIVE TYPE 3

110 volt pair of motor reducers with encoder and microchip that powers 2 motors and guarantees constant correct tension despite changes in fabric properties caused by temperature changes, with radio-control and 1 channel transmitter. Pulls 4 amps. Required for 4 or 5 runners Pergotenda®.

## MOTORIZATION Alba Louvered Roof Motors\*

\*Alba Louvered Roof systems are only available Motorized.



Alba's motor, fitted on the longitudinal side, is provided with a protection case that exceeds by 5.12 inches of the total height of the structure.







**KEEP  
CALM**  

---

**I'M AN**  
Outdoor  
**ALCHEMIST**  

---

[corradiusa.com](http://corradiusa.com)

“Why Corradi?”



**For over 40 years** we have been designing solutions that allow you to enjoy outdoor spaces as much as possible and for over 10 years we have extended our solutions to the USA. We have come a long way from the small artisanal workshop of 1978 to today's factories that use the best production technologies and distributes products throughout the world. We were the first to patent the product that embodies the archetype of shading, the perfect combination of a pergola and a sun shade. In addition to Pergotenda® we also offer Louvered Roof pergolas, Exterior Screens and various unique shading systems to give you the maximum selection to choose from. We have the same drive, the same enthusiasm that brought our company to life in the beginning. The desire to do well, to develop new innovations, to seek other points of view. The desire to invent your outdoor space of tomorrow. We put ourselves in your shoes and ask ourselves—

## “Why Corradi?”

- We have numerous patents that guarantee exclusivity and technical expertise.
- Pergotenda® is made only by Corradi.
- We have over 40 years of dedicated experience with outdoor spaces.
- Our products are custom made and can be personalized.
- Italian design is our signature.
- We have a wide range of products and services that is constantly evolving.
- We are able to produce concepts, executive designs, production and implementation, even for special projects.
- Our Dealers are chosen, prepared and trained to be the best
- We believe in the uniqueness of people and in teamwork
- Our mission is to allow you to enjoy living outdoors.



This catalogue, the information, technical features, product descriptions, names, images, photographs, reproductions, trademarks contained herein are an exclusive property of Corradi Srl & Corradi USA and are subject to the according norms for trademarks, patents, royalties, intellectual property and unfair competition. Without written authorization by Corradi, any reproduction, even partial, of the information, technical features, descriptions, names, images, photographs, trademarks in this catalogue is prohibited. The manufacturer may modify or improve the products in this catalogue without dispute. Differences in color tones may occur and depend on the reproduction technique.

disclaimer



# credits

General Coordination & Contents by  
**Marketing & Communication Corradi USA & Corradi EU**  
Erin Collis  
Sully Briskomatis

Cover Photo & Installation  
**Miami Awning, Miami FL, USA**

Photographic Services & Installation Images Corradi USA  
**Awnings & Signs by Pomfret, Cumberland RI**  
**Blind Appeal, Nampa ID**  
**Bob's Canvas, Murietta CA**  
**Charlotte Tent & Awning, Charlotte NC**  
**Conroe Awning and Screen, Conroe TX**  
**The Deck Awning Company, Gaithersburg MD**  
**The Dorchester Awning Company, Kingston MA**  
**Kraft Mobil Screen Service, Wilsonville CA**  
**Longhorn Solar Screens, Denton TX**  
**Made in the Shade Inc., Las Vegas NV**  
**Miami Awning, Miami FL**  
**New Haven Awning, New Haven CT**  
**Outdoor Living Solutions, London ON, Canada**  
**Pure Tech Window Fashion, Seattle WA**  
**Total Shade, Frisco TX**  
**We Got You Covered Outdoor, Mooresville NC**  
**Window Products Management, Ventura CA**

Photographic Services & Images Corradi EU  
**Arch018**  
**Studio Baraldi**  
**Studio Cappelli**  
**Vito Corvasce for Archikiller/Quid Editori**  
**Dominique Coulon & Associés**  
**Giovanni de Sandre**  
**Caterina Leonelli**  
**Modo Fotografia**  
**Michele Pietrobon**  
**Giulia Sacchetta**  
**Carola Fachechi**  
**Riccardo Urnato Fotografo**  
**Rosa Amato — ArchitPhoto**  
**Serge Brison**  
**Davide Sala for VG Crea**  
**Federica Conti**  
**Ischia City**  
**Cupola Home Solutions**  
**Dirk Van Overwalle — DVO Photographic**

Special thanks to  
**Our Dealers for being the best**

Printing  
**Digital Marketing & Print**



THE  
outdoor  
ALCHEMIST





**Corradi USA**  
1910 N Josey Ln, Carrollton, TX 75006  
T +1 800 882 8393  
E info@corradiusa.com  
**www.corradiusa.com**

