

A⁺ SINK

USAN KITCHEN AND BATH CO.,LTD
STAINLESS STEEL SINK



WWW.USANSINK.COM

COMPANY INFORMATION

Guangdong USAN Kitchen and Bath Co.,Ltd, we are one of the leading Stainless Steel Sinks MFG in Guangdong China, specializing in the production of stainless steel kitchen and bathroom products, and has more than 10 years of experience in kitchen and bathroom products export. We have experience in production, sales, wholesale and trade.

With CUPC and ISO9001 certifications, we bring a complete series of high-quality and affordable kitchen and bathroom sinks and faucets to the market.

We only use the most advanced materials and the most modern manufacturing technology - to ensure that our products are of high quality. Each product is designed and manufactured to meet the requirements of modern requirements, has undergone strict quality control procedures, and has obtained independent test certification.

We also have the ability to design and manufacture exclusive products for our customers and provide them with a useful competitive advantage in the rapidly changing market.

Products and packaging can be based on the customer's brand and code - this helps to establish the customer's brand identity.

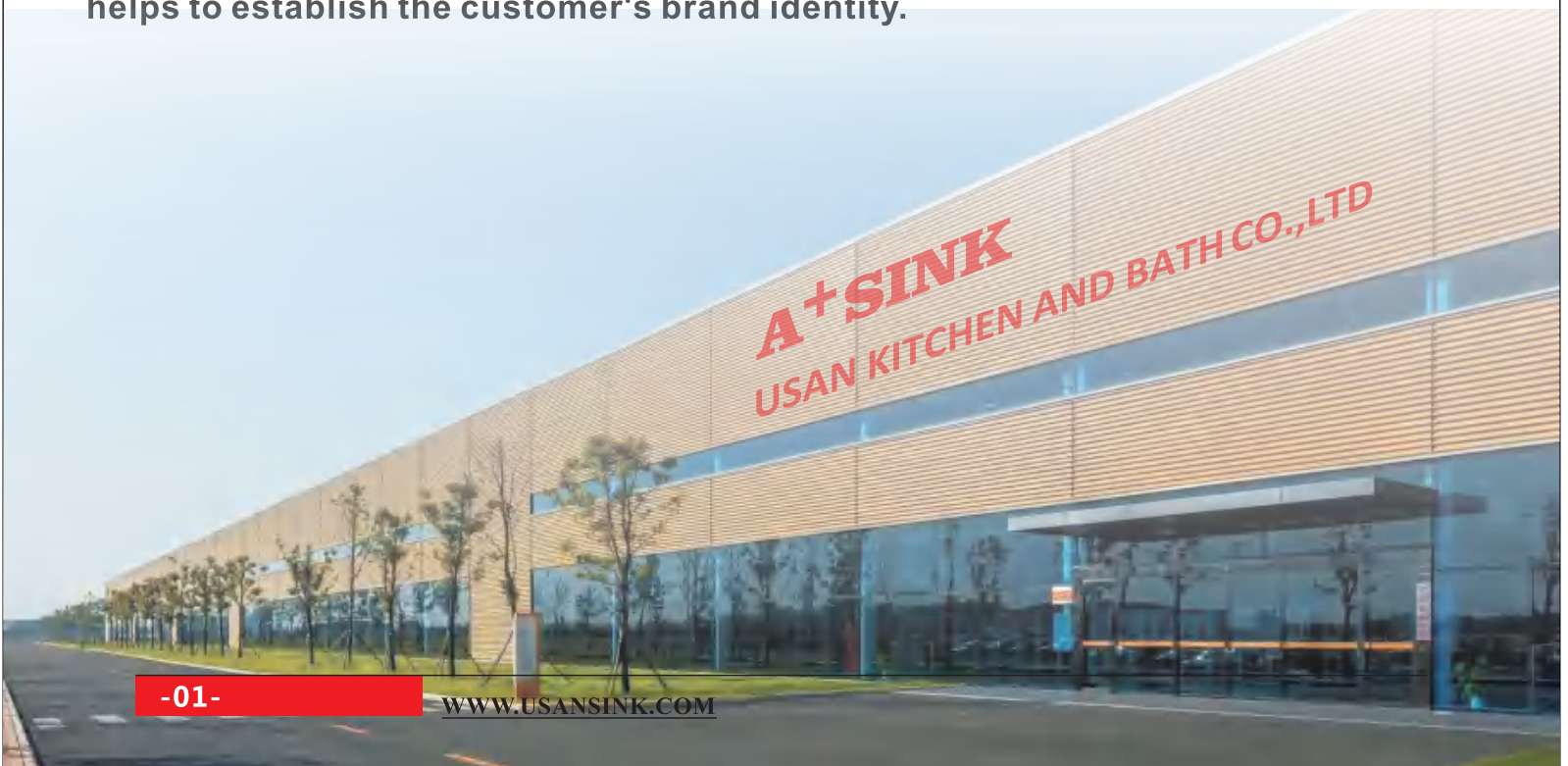

IAPMO RESEARCH AND TESTING, INC.

5001 E. Philadelphia Street, Ontario, CA 91761 • Phone (909) 472-4100 • Fax (909) 472-4244 • www.iapmort.org



CERTIFICATE OF LISTING



IAPMO Research and Testing, Inc. is a product certification body in which its product certification system includes inspection and testing of samples taken from the supplier's stock or from the market or a combination of both to verify compliance to the requirements of applicable codes and standards. This activity is coupled with periodic surveillance of the supplier's factory and/or warehouses as well as the assessment of the supplier's Quality Assurance System. This listing is subject to the conditions set forth in the characteristics below and is not to be construed as any recommendation, assurance or guarantee by IAPMO Research and Testing, Inc. of the product acceptance by Authorities Having Jurisdiction.

Issued To:

USAN KITCHEN AND BATH CO.,LTD

NO.9 DONGDI THIRD RD, PENGJIANG DISTRICT 529000 JIANGMEN , GUANGDONG, CHINA

Product:

Plumbing Fixtures (Stainless Steel)

Products are in compliance with the following code(s):

**Uniform Plumbing Code (UPC®)
National Plumbing Code of Canada**

Products are certified to the following standard(s)

ASME A112.19.3-2017/CSA B45.4-17e2

File Number: 13941

Effective Date: March 2023

Void After: March 2028*

Chairman, Product Certification Committee





Chief Technical Service Officer

*This certificate is not evidence of current listing. To verify listing status, visit the IAPMO R&T Product Listing Directory at pld.iapmo.org

This listing period is based upon the last date of the month indicated on the Effective Date and Void After Date shown above. Any change in material, manufacturing process, marking or design without having first obtained the approval of the Product Certification Committee, or any evidence of non-compliance with applicable codes and standards or of inferior workmanship, may be deemed sufficient cause for revocation of this listing. Production of or reference to this form for advertising purposes may be made only by specific written permission of IAPMO Research and Testing, Inc. Any alteration of this certificate could be grounds for revocation of the listing. This document shall be reproduced in its entirety.

SINKS AND SHOWER NICHE IN COLORS

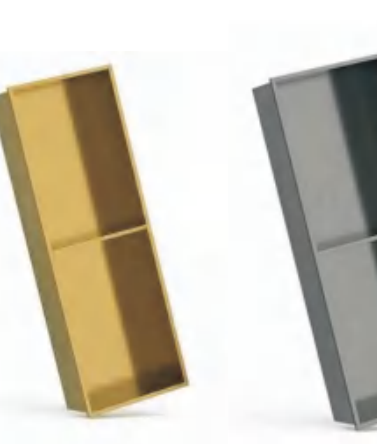
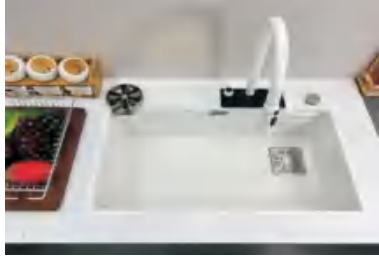
Sizes and Designs are Optional



Stainless Steel Sink in Nano Technology Colors: Matte Black, Copper, Gold, Gunmetal With Anti Scratching



AF3117MB

OVERALL: 31"x17"
 DEPTH: 9",10"
 FINISH: Matte Black

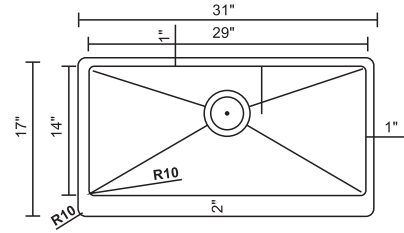

AF3117G

OVERALL: 31"x17"
 DEPTH: 9",10"
 FINISH: Gunmetal

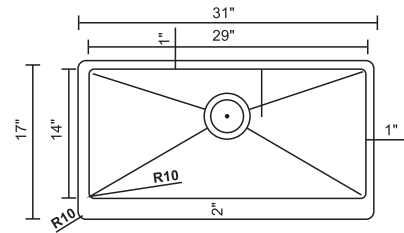

AF3021C

OVERALL: 30"x21"
 DEPTH: 9",10"
 FINISH: Copper colour

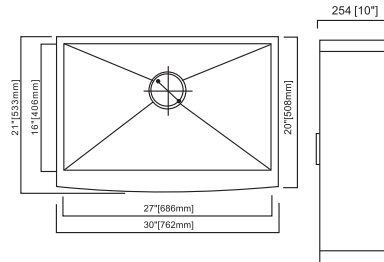

AF3021G

OVERALL: 30"x21"
 DEPTH: 9",10"
 FINISH: Gold colour

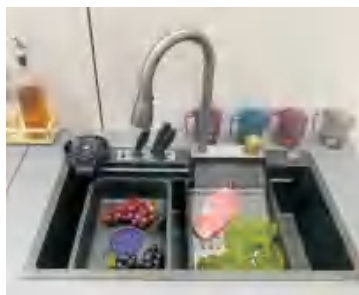
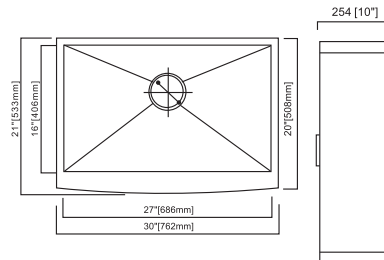

GOLF FINISHING SINKS
 Sizes :750x450x220mm
 800x450x220mm



APRON FARM SINK-Square Corner, Radius Corner of 10 & 15 Degree are available

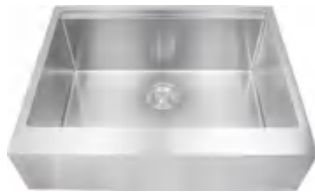

AF2722FB

OVERALL: 27"x22"
DEPTH: 9", 10"
FINISH: All Satin

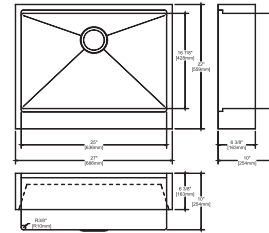

AF3021FB

OVERALL: 30"x21"
DEPTH: 9", 10"
FINISH: All Satin

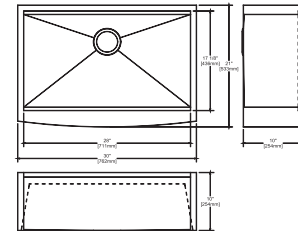

AF3021FRB

OVERALL: 30"x21"
DEPTH: 9", 10"
FINISH: All Satin

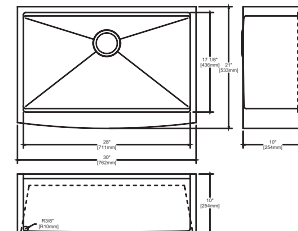

AF3321FB

OVERALL: 33"x21"
DEPTH: 9", 10"
FINISH: All Satin

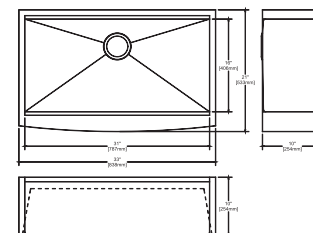

AF3321FRB

OVERALL: 33"x21"
DEPTH: 9", 10"
FINISH: All Satin

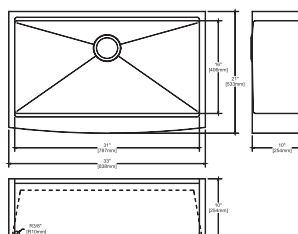

DUAL MOUNT TOP-UNDERMOUNT APRON CABINET SINK

APRON FARM SINK-Square Corner, Zero Radius, Radius Corner of 10 & 15 Radius are available



AF3022F

OVERALL: 30"x21-7/8"

DEPTH: 9", 10"

FINISH: All Satin

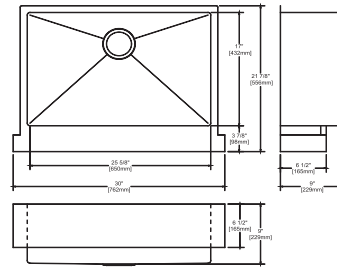

AF3022FD

OVERALL: 30"x21-7/8"

DEPTH: 9", 10"

FINISH: All Satin

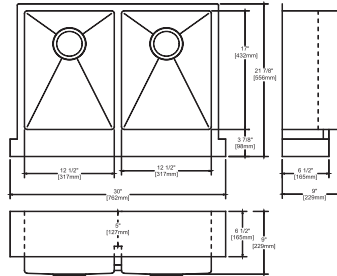

AF3322F

OVERALL: 33"x21-7/8"

DEPTH: 9", 10"

FINISH: Satin

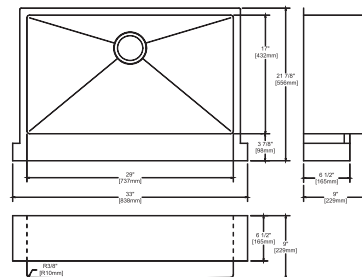

AF3322FD

OVERALL: 33"x21-7/8"

DEPTH: 9", 10"

FINISH: Satin

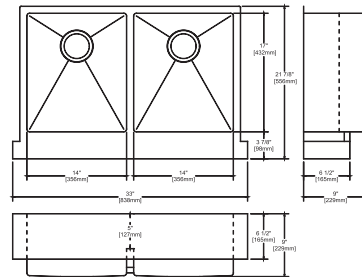

CUP WASHER

APRON FARM SINK-Square Corner, Radius Corner of 10 & 15 Degree are available



AFS3022F

OVERALL: 30"x22-1/4"
DEPTH: 10"
FINISH: All Satin

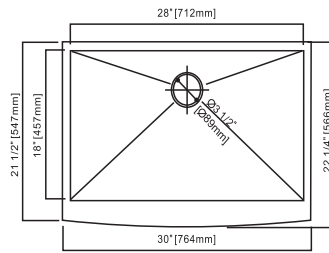

AFS3022FR

OVERALL: 30"x22-1/4"
DEPTH: 10"
FINISH: All Satin

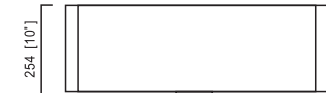
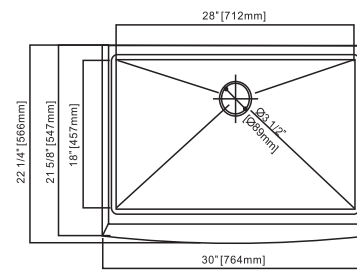

AFS3322F

OVERALL: 33"x22-1/4"
DEPTH: 10"
FINISH: All Satin

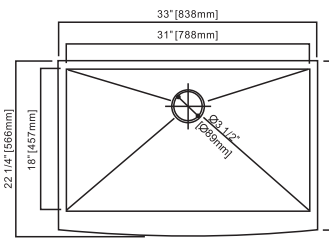

AFS3322FR

OVERALL: 33"x22-1/4"
DEPTH: 10"
FINISH: All Satin

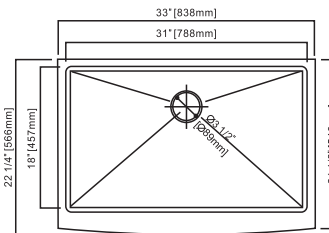

AFD3322F

OVERALL: 33"x22-1/4"
DEPTH: 10"
FINISH: All Satin

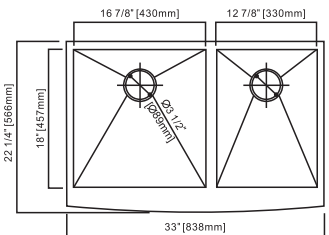

AFD3322FR

OVERALL: 33"x22-1/4"
DEPTH: 10"
FINISH: All Satin

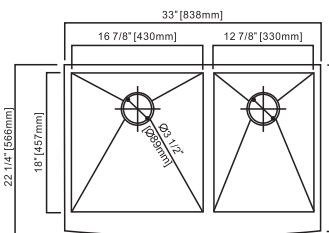

APRON FARM SINK-Square Corner, Radius Corner of 10 & 15 Degree are available



AF3622

OVERALL: 36"x22-1/4"
DEPTH: 10"
FINISH: All Satin

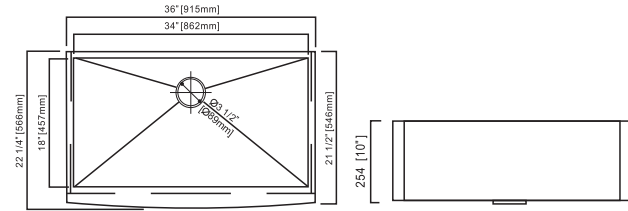

AF3622R

OVERALL: 36"x22-1/4"
DEPTH: 10"
FINISH: All Satin

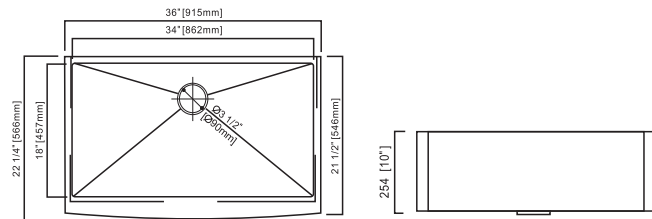

AFD3622L

OVERALL: 36"x22-1/4"
DEPTH: 10"
FINISH: All Satin

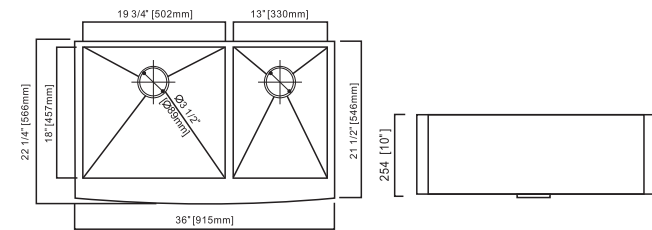

AFD3622R

OVERALL: 36"x22-1/4"
DEPTH: 10"
FINISH: All Satin

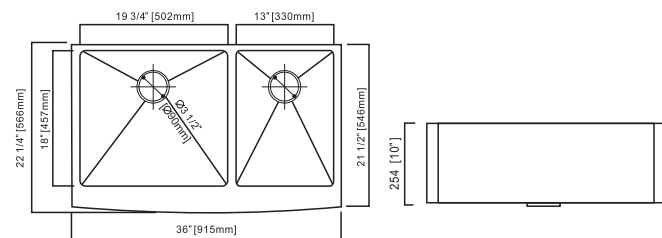

AF3021

OVERALL: 30"x21"
DEPTH: 10"
FINISH: All Satin

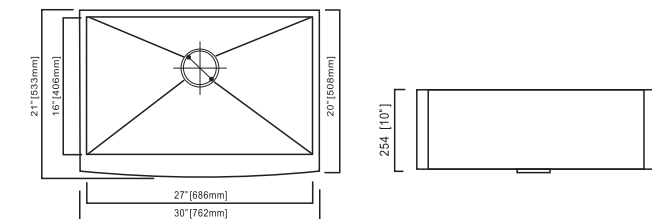

AF3621

OVERALL: 36"x21"
DEPTH: 10"
FINISH: All Satin

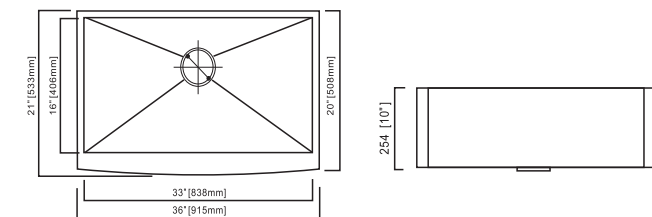

Square Corner, Radius Corner of 10 & 15 Degree are available



US2318

OVERALL: 23"x18"
DEPTH: 10"
FINISH: All Satin

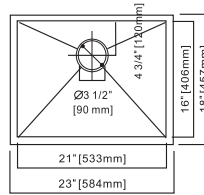

US2320

OVERALL: 23"x20"
DEPTH: 10"
FINISH: All Satin

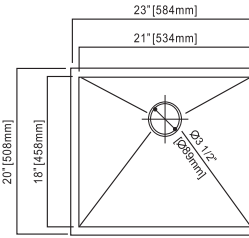

US2320R

OVERALL: 23"x20"
DEPTH: 10"
FINISH: All Satin

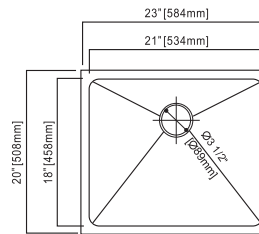

US3018

OVERALL: 30"x18"
DEPTH: 10"
FINISH: All Satin

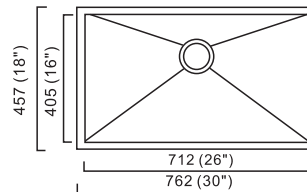

US3019R

OVERALL: 30"x19"
DEPTH: 10"
FINISH: All Satin

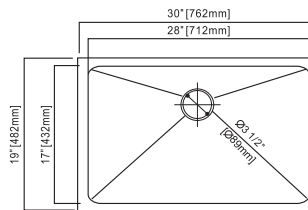

US3219

OVERALL: 32"x19"
DEPTH: 10"
FINISH: All Satin

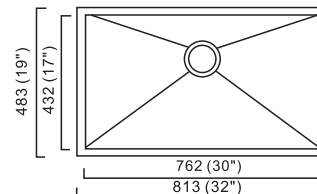

Square Corner, Radius Corner of 10 & 15 Degree are available



UD3219

OVERALL: 32"x19"
DEPTH: 10"
FINISH: All Satin

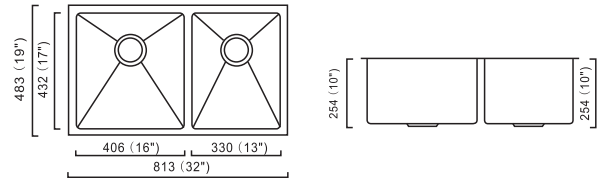

UD2920

OVERALL: 29"x20"
DEPTH: 10"
FINISH: All Satin

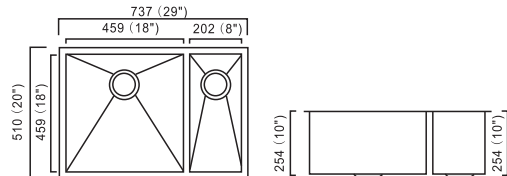

UD2920B

OVERALL: 29"x20"
DEPTH: 10"
FINISH: All Satin

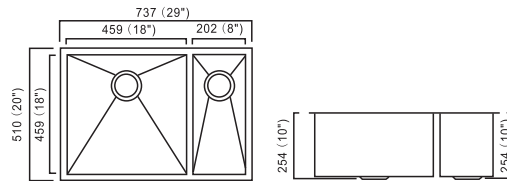

UD3320

OVERALL: 33"x20"
DEPTH: 10"
FINISH: All Satin

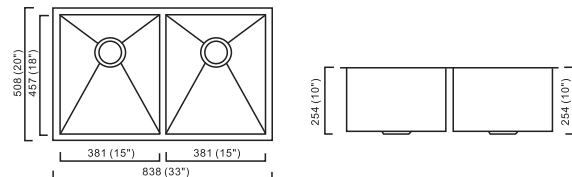

UD3320B

OVERALL: 33"x20"
DEPTH: 10"
FINISH: All Satin

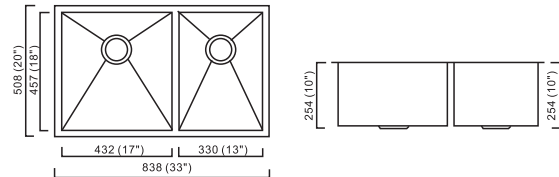

UD5221

OVERALL: 51½" x 20¾"
DEPTH: 8"
FINISH: All Satin

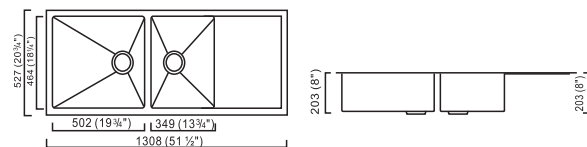

Square Corner, Radius Corner of 10 & 15 Degree are available



US3322

OVERALL: 33"x22"
DEPTH: 9"
FINISH: All Satin

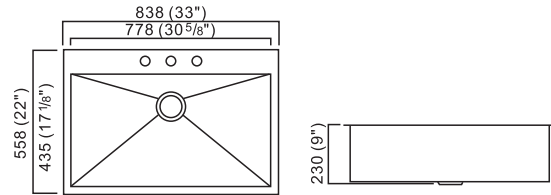

US3120

OVERALL: 31 1/2" x 20 1/2"
DEPTH: 9"
FINISH: All Satin

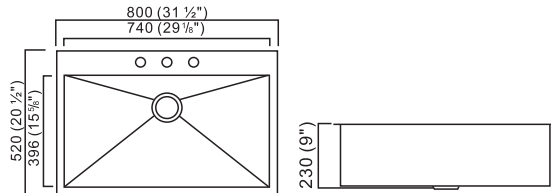

UD3120

OVERALL: 31 1/2" x 20 1/2"
DEPTH: 9"
FINISH: All Satin

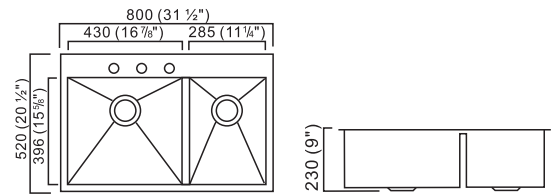

UD3120B

OVERALL: 31 1/2" x 20 1/2"
DEPTH: 9"
FINISH: All Satin

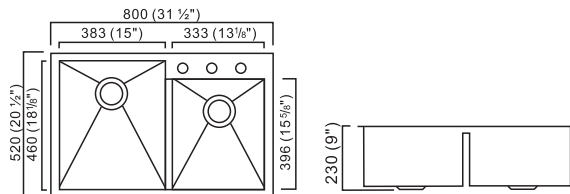

UD3322

OVERALL: 33" x 22"
DEPTH: 9"
FINISH: All Satin

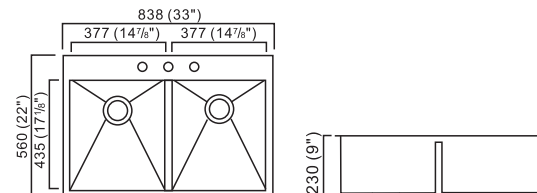

UD3322B

OVERALL: 33" x 22"
DEPTH: 9"
FINISH: All Satin

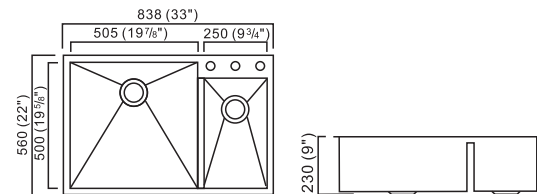

Square Corner, Radius Corner of 10 & 15 Degree are available



US2244

Dimensioni: 440x440mm
 Size
 h.vasca: 130mm/175mm
 foro.scarico: 3.5
 Waste.hole

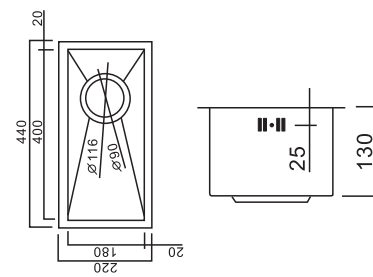

US4444

Dimensioni: 440x440mm
 Size
 h.vasca: 175mm/230mm
 foro.scarico: 3.5
 Waste.hole

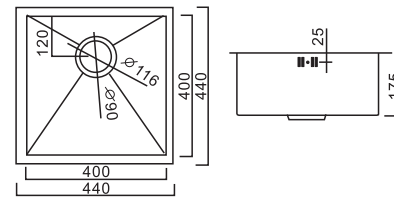

US1518

OVERALL: 15 1/4" x 17 3/4"
 DEPTH: 9"
 FINISH: All Satin

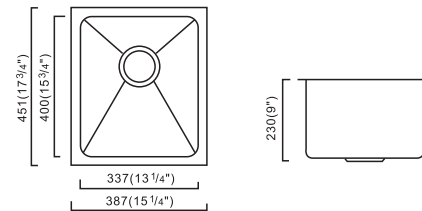

UD5945

Dimensioni: 585x440mm
 Size
 h.vasca: 175mm/230mm
 foro.scarico: 3.5
 Waste.hole

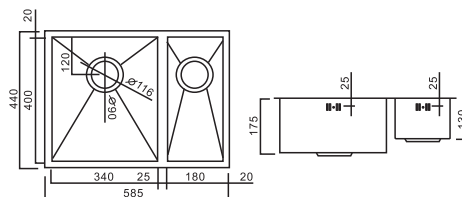

UD6245

Dimensioni: 615x450mm
 Size
 h.vasca: 175mm/225mm
 foro.scarico: 3.5
 Waste.hole

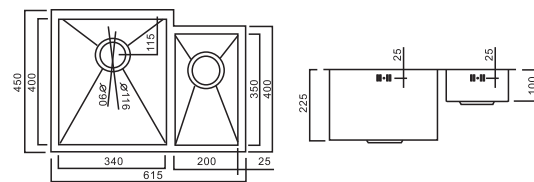

UD8152

Dimensioni: 807x520mm
 Size
 h.vasca: 175mm/250mm
 foro.scarico: 3.5
 Waste.hole

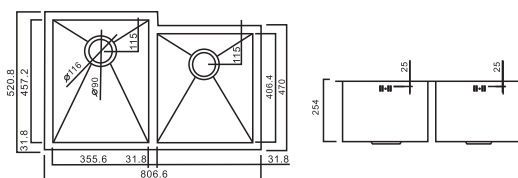

Square Corner, Radius Corner of 10 & 15 Degree are available



US2244R

OVERALL: 220x440mm
DEPTH: 145mm
FINISH: All Satin

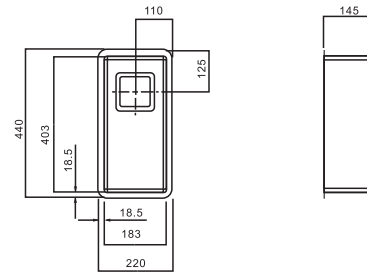

US4444R

OVERALL: 440x440mm
DEPTH: 180mm
FINISH: All Satin

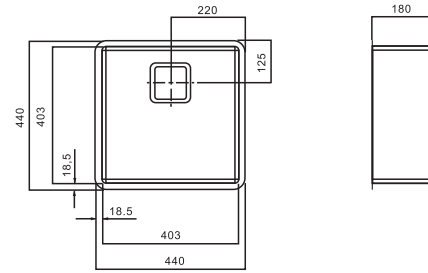

UD5544R

OVERALL: 553x440mm
DEPTH: 180mm, 145mm
FINISH: All Satin

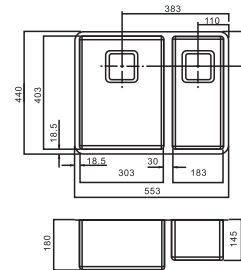

UD6544R

OVERALL: 653x440mm
DEPTH: 180mm, 145mm
FINISH: All Satin

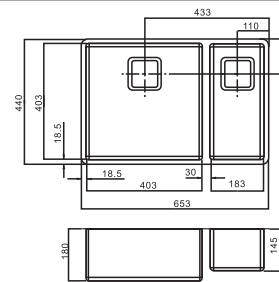

UD4744R

OVERALL: 673x440mm
DEPTH: 180mm, 180mm
FINISH: All Satin

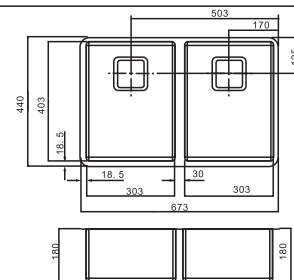

UD8744R

OVERALL: 873x440mm
DEPTH: 180mm, 180mm
FINISH: All Satin

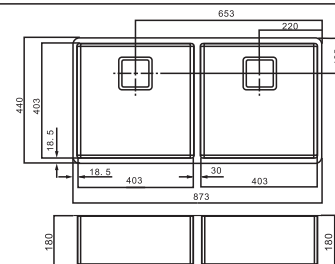



USS1616

OVERALL: 16"x16"
DEPTH: 8"
FINISH:All Satin / Deck Polish, Bowl Satin

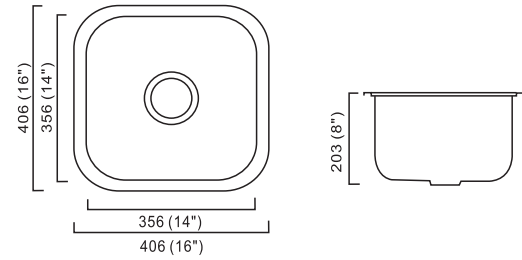

USS1816

OVERALL: 18"x16"
DEPTH: 8"
FINISH:All Satin / Deck Polish, Bowl Satin

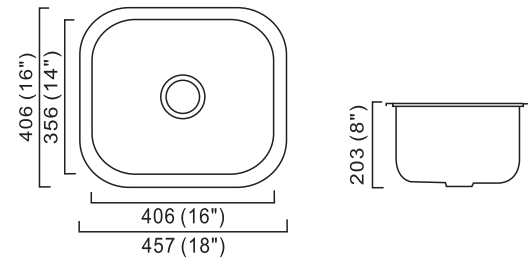

USS2318

OVERALL: 23"x17 3/4"
DEPTH: 9"
FINISH:All Satin / Deck Polish, Bowl Satin

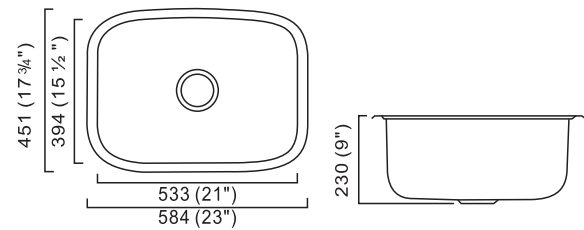

USS2321

OVERALL: 23 1/2"x21"
DEPTH: 9"
FINISH:All Satin / Deck Polish, Bowl Satin

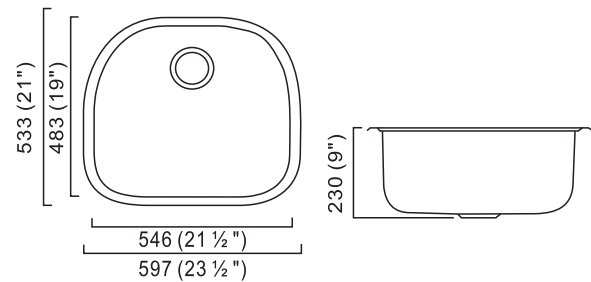

USS2718

OVERALL: 27-1/6"x17-7/8"
DEPTH: 9"
FINISH:All Satin

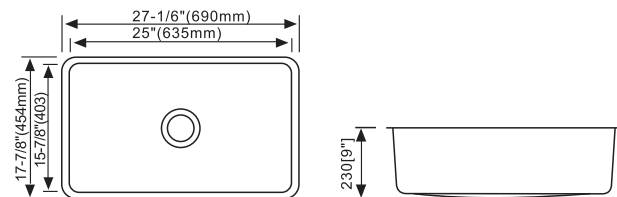

USS2918

OVERALL: 29"x18"
DEPTH: 8", 9"
FINISH:All Satin

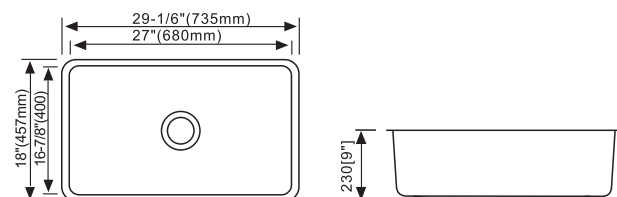



USS3018

OVERALL: 30"x18"
DEPTH: 9", 10
FINISH: All Satin/Deck Polish, Bowl Satin

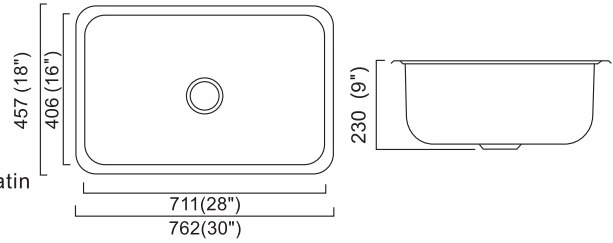

USD3118

OVERALL: 31¹/₄"x18"
DEPTH: 9"/9"
FINISH: All Satin/Deck Polish, Bowl Satin

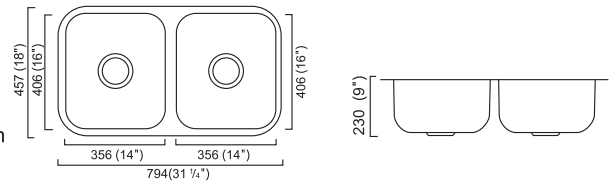

USD3218

OVERALL: 32¹/₂"x18¹/₄"
DEPTH: 9"/9"
FINISH: All Satin/Deck Polish, Bowl Satin

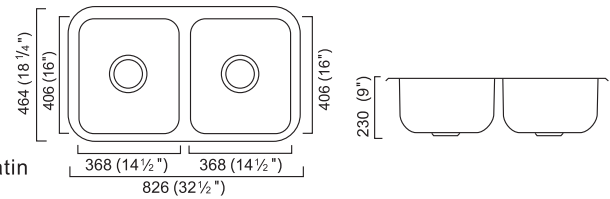

USD3221

OVERALL: 31³/₄"x20¹/₂"
DEPTH: 9"/8"
FINISH: All Satin / Deck Polish, Bowl Satin
 ★ Opposite Is available.

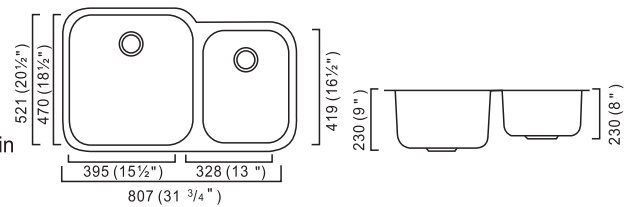

USD3221B

OVERALL: 31¹/₂"x20¹/₂"
DEPTH: 9"/7"
FINISH: All Satin / Deck Polish, Bowl Satin
 ★ Opposite Is available.

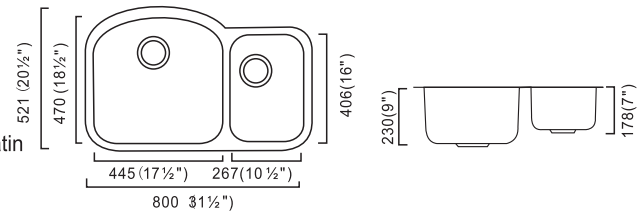

USD2918

OVERALL: 29"x18"
DEPTH: 8", 9"
FINISH: All Satin

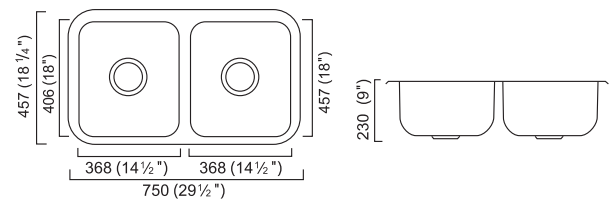



UTS1515

OVERALL: 15"x15"
DEPTH: 5 1/2"
FINISH: Satin / Polish

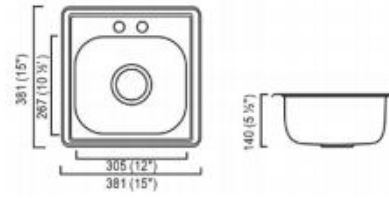

UTS1919

OVERALL: 19"x19"
DEPTH: 6", 7", 8"
FINISH: Satin/ Polish

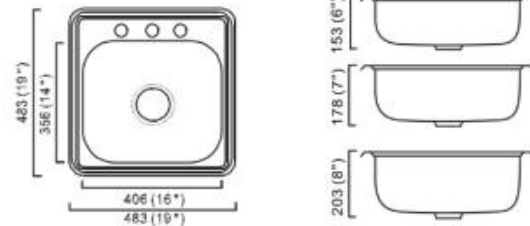

UTS2522

OVERALL: 25"x22"
DEPTH: 6", 7", 8"
FINISH: Satin/ Polish

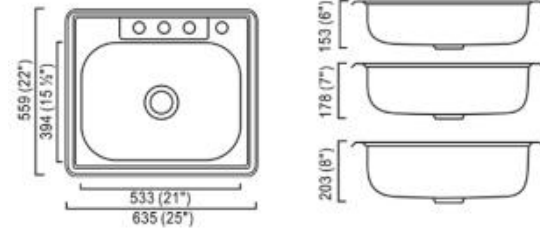

UTD3319

OVERALL: 33"x19"
DEPTH: 6", 7", 8"
FINISH: Satin/ Polish

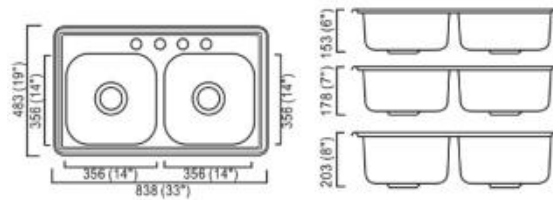

UTD3322

OVERALL: 33"x22"
DEPTH: 6", 7", 8"
FINISH: Satin/ Polish

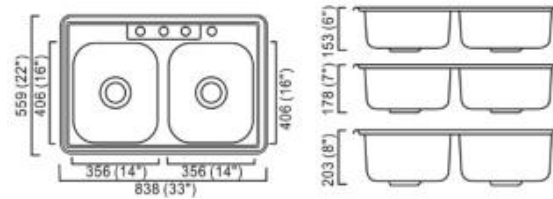

UTD3322C

OVERALL: 33"x22"
DEPTH: 6", 7", 8"
FINISH: Satin/ Polish

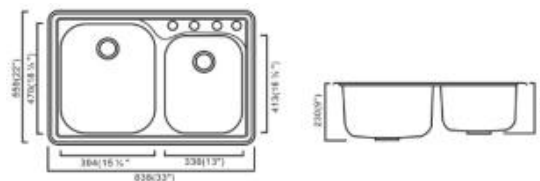



UTS8050

OVERALL: 800 x 500mm
DEPTH: 6"
FINISH: Satin / Polish
 ★ Opposite is available.

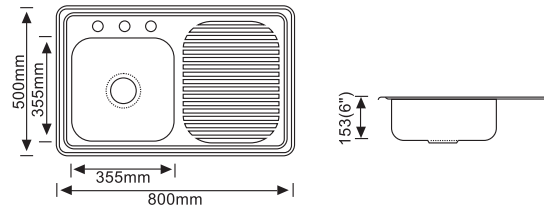

UTS8050H

OVERALL: 800 x 500mm
DEPTH: 6"
FINISH: Satin / Polish
 ★ Opposite is available.

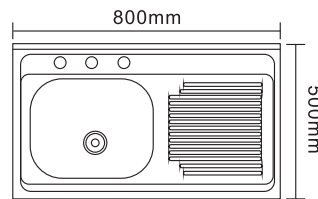

UTS8052

OVERALL: 800 x 520mm
DEPTH: 6"
FINISH: Satin / Polish
 ★ Opposite is available.

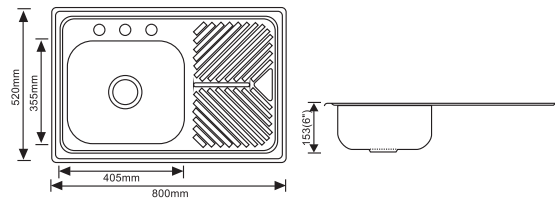

UTS10050

OVERALL: 1000 x 500mm
DEPTH: 6"
FINISH: Satin / Polish
 ★ Opposite is available.

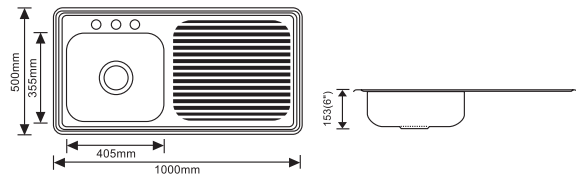

UTD12050

OVERALL: 1200 x 500mm
DEPTH: 6"
FINISH: Satin / Polish
 ★ Opposite is available.

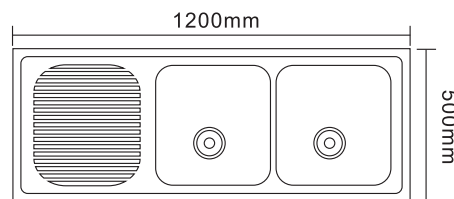

UTD15050

OVERALL: 1500 x 500mm
DEPTH: 6"
FINISH: Satin / Polish
 ★ Opposite is available.

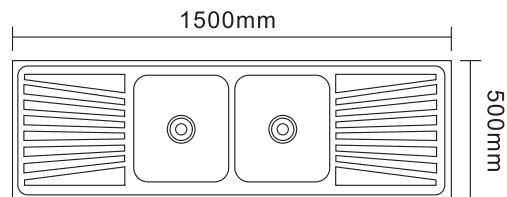

TOP QUALITY VANITY STAINLESS STEEL SINK



V-4037

OVERALL: 15-3/4"x14-5/8"
400x370mm

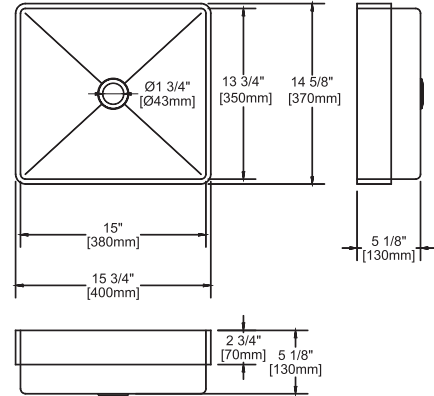

V-4040

OVERALL: 15-3/4"x15-3/4"
400x400mm

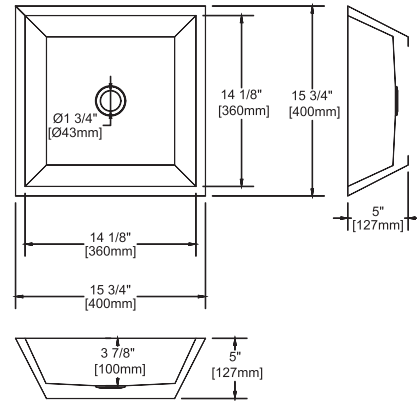

V-4242

OVERALL: 16-1/2"x16-1/2"
420x420mm

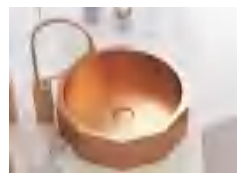
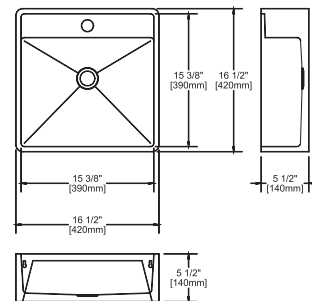

SUS 304 STAINLESS STEEL FAUCET



S-1611



S-1612



S-1812



S-1913



S-1512



S-1613

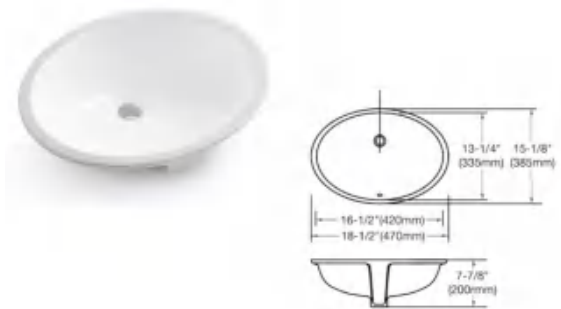

S-1714



S-1919



T-6838



One Piece Toilet
Size: 680×380×760mm

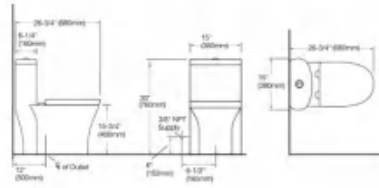

Flushing system: Siphonic
S trap: 300mm

T-7037



One Piece Toilet
Size: 700×368×742mm

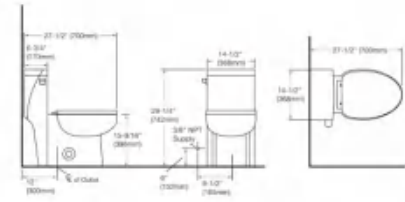

Flushing system: Siphonic
S trap: 300mm

T-7042



One Piece Toilet
Size: 705×420×605mm

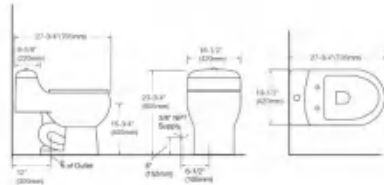

Flushing system: Siphonic
S trap: 300mm

T-7338



One Piece Toilet
Size: 727×375×663mm

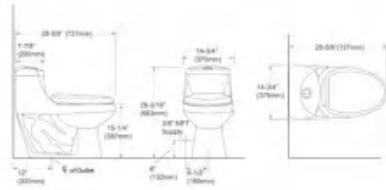

Flushing system: Siphonic
S trap: 300mm

T-7342



One Piece Toilet
Size: 733×415×698mm

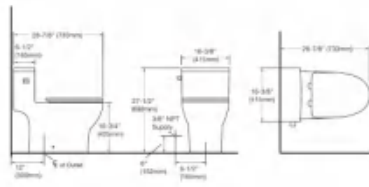

Flushing system: Siphonic
S trap: 300mm

T-7336



One Piece Toilet
Size: 730×358×710mm

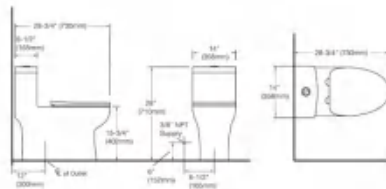

Flushing system: Siphonic
S trap: 300mm

T-7439



One Piece Toilet
Size: 740×390×770mm

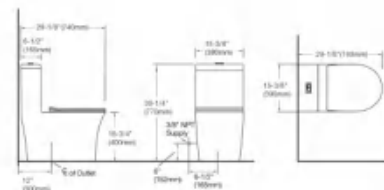

Flushing system: Siphonic
S trap: 300mm

T-7739



One Piece Toilet
Size: 770×390×720mm

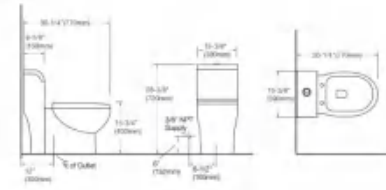

Flushing system: Siphonic
S trap: 300mm

BC-6046A

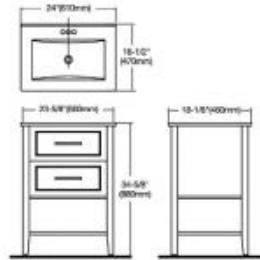

Basin: 610×470mm
Cabinet: 600×460×880mm

BC-6046B

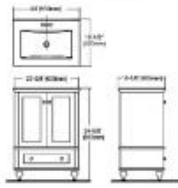

Basin: 610×470mm
Cabinet: 600×460×880mm

BC-6946

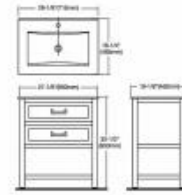

Basin: 715×465mm
Cabinet: 690×460×850mm

BC-6046 White

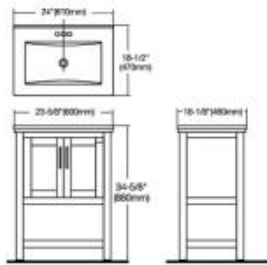

Basin: 610×470mm
Cabinet: 600×460×880mm

BC-11845

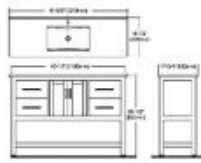

Basin: 1210×470mm
Cabinet: 1180×450×850mm

BC-7946

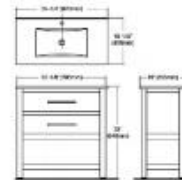

Basin: 820×465mm
Cabinet: 790×455×840mm

WWW.USANSINK.COM



A⁺SINK

USAN KITCHEN AND BATH CO.,LTD

Address: NO.9 Dongdi third Rd, Pengjiang District,
Jiangment City, Guangdong, China

Poscode: 529000

Website: WWW.USANSINK.COM

Email: linda@usansink.com

Phone: +8613924873337