

ALUMINIUM FENCE  
SINCE 2006

ALUMINIUM BALUSTRADE  
SINCE 2006

GLASS BALUSTRADE  
SINCE 2010

ALUMINIUM LOUVRE, SHUTTER & FACADE  
SINCE 2010

ALUMINIUM LOUVERED PERGOLA  
SINCE 2015

CANTILEVER UMBRELLA  
SINCE 2022



**Guangdong YONGFENG LIHUA Shading Technology Co., Ltd.**

6<sup>th</sup> Floor, Chengzhi Building, Haiwu Road, Guicheng Street, Nanhai District,  
Foshan City, Guangdong, China

+86-757-86203833    info@sunlever.cn    WWW.SUNLEVER.NET



Nature lover

Global Aluminium Outdoor Shading Solutions Provider

Global Leading Design- Up to 7 meters span of louvered pergola in one module (E300)



**PERGOLA & CANTILEVER UMBRELLA**



## ABOUT SUNLEVER



### Guangdong YONGFENG LIHUA Shading Technology Co., Ltd.

We started as the Finished Product Department of Foshan City Nanhai YONGFENG Aluminum Co., Ltd. in 2007. After the development and expansion for over 15 years, we established **Guangdong YONGFENG LIHUA Shading Technology Co., Ltd. (SunLever) in 2020.**

We started a new journey in the outdoor leisure and shading field with our new brand, new enterprise and new mission.

Our vision is to **“Make high-end outdoor sunshine items as non-luxury goods”**, we commit to develop and manufacture diversified outdoor shading products that are suitable for global needs. “Enjoy sunshine in comfort”, be willing to create tranquil and cozy shading space for outdoor living lovers.

Responding to the requirements of the times, we will keep on expanding and innovating, **strive to be world’s leading supplier of outdoor shading products.**

## STANDARD PRODUCTS IN SUNLEVER



FIXED PERGOLA



CANTILEVER UMBRELLA

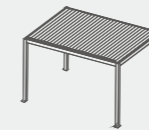

LOUVERED PERGOLA





# LOUVERED PERGOLA -PRODUCT INTRODUCTION

**SunLever Louvered Pergola** is a new type of outdoor shading solution that takes into accounts both practicality and fashion.

The adjustable blades provide the most comfortable outdoor space experience. The electric or manual control system diversifies in multipurpose scenarios. The standard or customized sizes integrate in different design styles and application.

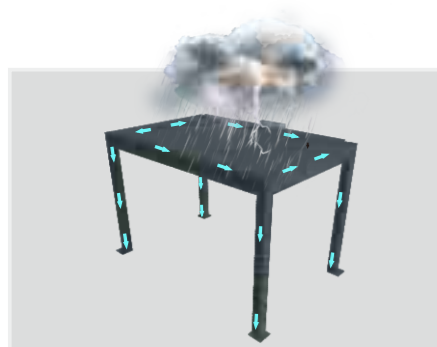

The sealing tape is built into the blade to achieve better waterproof



Pass the wind test of grade 12 (> 117km/h, 63.5-71.8mph)



The aluminium double-layer blades can isolate sun radiation heat & conduction heat.

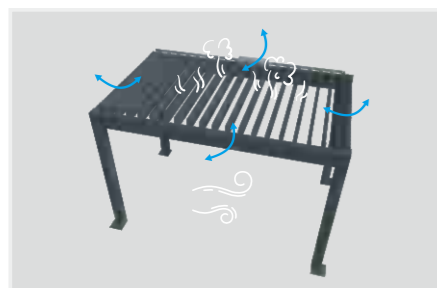

Hot air to be convected out of blades, achieving ventilation and heat dissipation



Adjust sunlight penetrated through refraction by blade angle of 0-120 degrees.



Load capability of 200kg/M<sup>2</sup> allow snow height of one meter on the blade of per square meter.



# LOUVERED PERGOLA -CONTROL SYSTEM

## Electric Pergola System



## Manual Pergola System



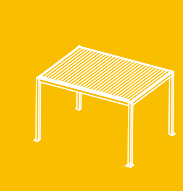

## Garden

Build a LOUVERED PERGOLA in garden is to create an all-weather outdoor leisure space for family and friends to communicate emotionally and enjoy happiness of daily life.

Without Pergola

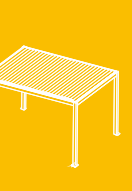

VS



Pergola built

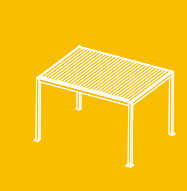

## Outdoor Restaurant

There is no doubt that dining in a well-ventilated and spacious place will be more comfortable. And we can enjoy the view outside at the same time. So there is a growing demand for outdoor restaurant. When build a LOUVERED PERGOLA above the outdoor restaurant, we can not only use it on sunny days, but also not afraid of rain.



Without Pergola

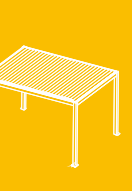

VS



Pergola built

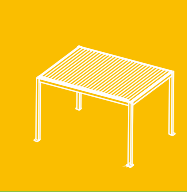

# LOUVERED PERGOLA -APPLICATION

## Swimming Pool

Build a LOUVERED PERGOLA next to the swimming pool as a sunshade and rest area. Beach chairs and outdoor furniture can be placed under the pergola, which can greatly improve the convenience and comfort of outdoor swimming.

Without Pergola



# LOUVERED PERGOLA -APPLICATION

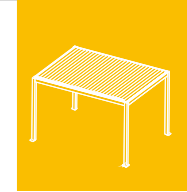

# Vs



Pergola built

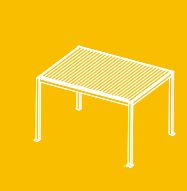

# LOUVERED PERGOLA -APPLICATION

## Hotel

Build a PERGOLA in the outdoor public activity area of the hotel as a sunshade and rest area, improve the utilization rate of outdoor space, reduce the use of indoor lighting and air conditioners, to save energy.



# LOUVERED PERGOLA -APPLICATION

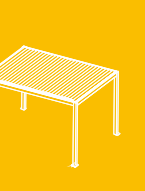

# VS





# LOUVERED PERGOLA -CATEGORY

## M140S (Lucida)

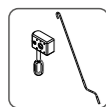

Manual

Schematic diagram of single module with 4 posts:

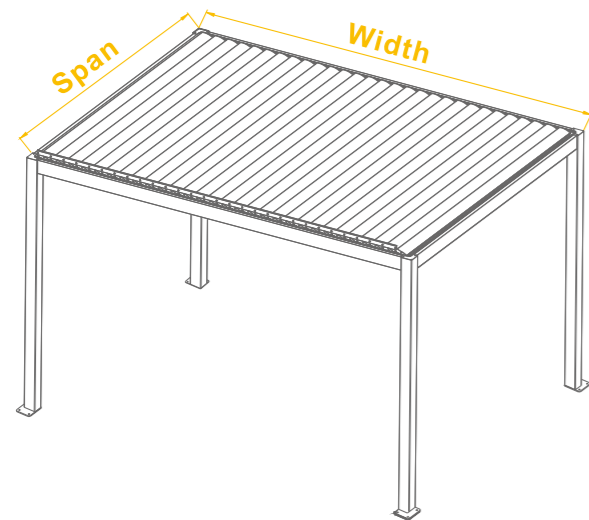

Schematic diagram of single module with 6 posts:

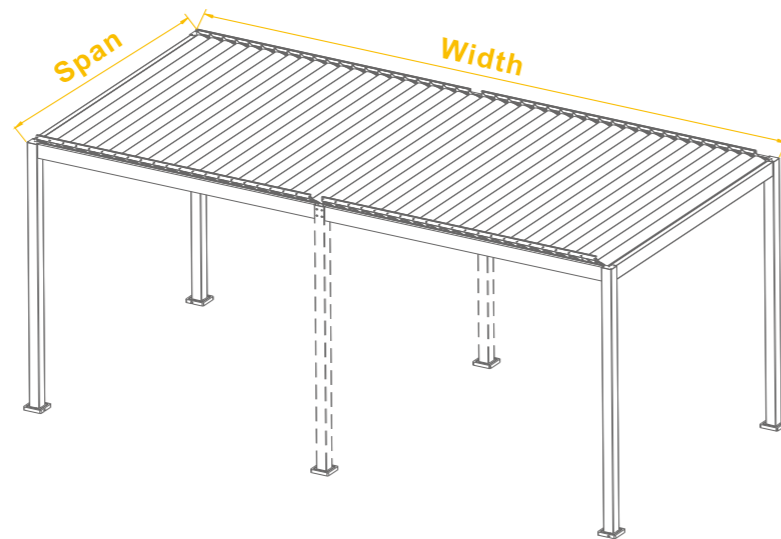

### Profiles section view

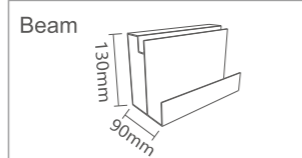
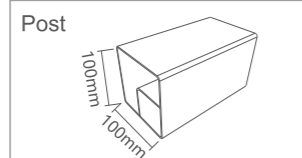
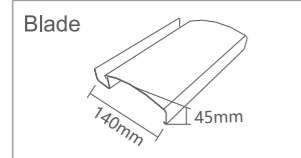

### M140S Standard Size

Width	Span	QTY of post
3m	3m	4
4m	3m	4
5m	3m	4
6m	3m	6

### Standard Color



Dark Gray  
YFC30041  
RAL7043



Matt White  
YFS10001  
RAL9016

# LOUVERED PERGOLA -CATEGORY



## M140/E140 (Stellar)

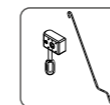

Manual



Electric

Schematic diagram of single module with 4 posts:

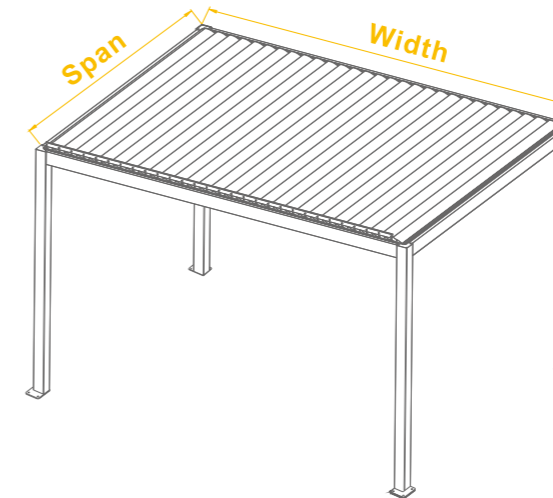

Schematic diagram of single module with 6 posts:

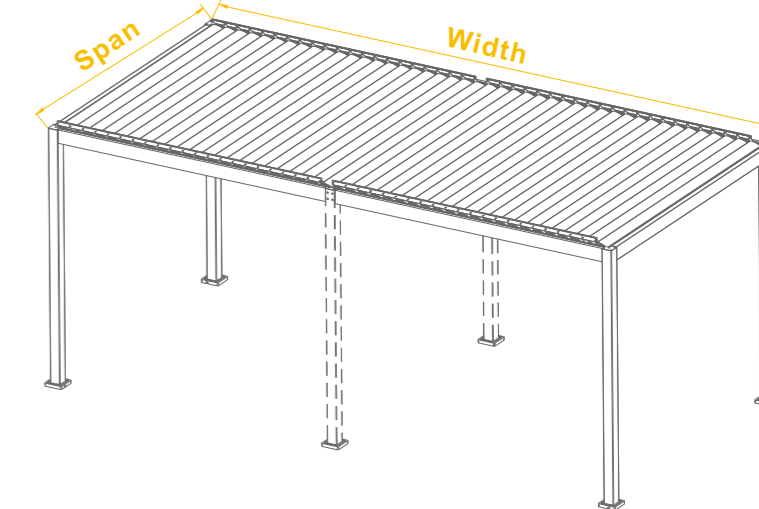

### Profiles section view

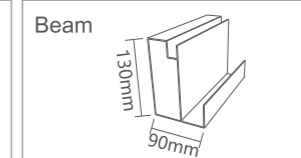
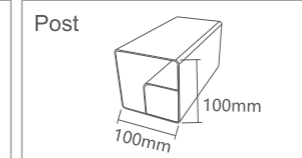
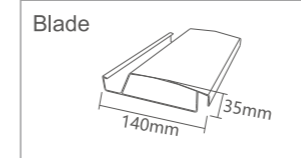

### M140/E140 Standard Size

Width	Span	QTY of post
3m	3m	4
4m	3m	4
5m	3m	4
6m	3m	6
4m	4m	4

### Standard Color



Dark Gray  
YFC30041  
RAL7043



Matt White  
YFS10001  
RAL9016



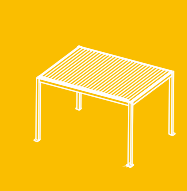

# LOUVERED PERGOLA -CATEGORY

## M170/E170 (Aurora)

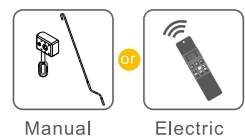

Schematic diagram of single module with 4 posts:

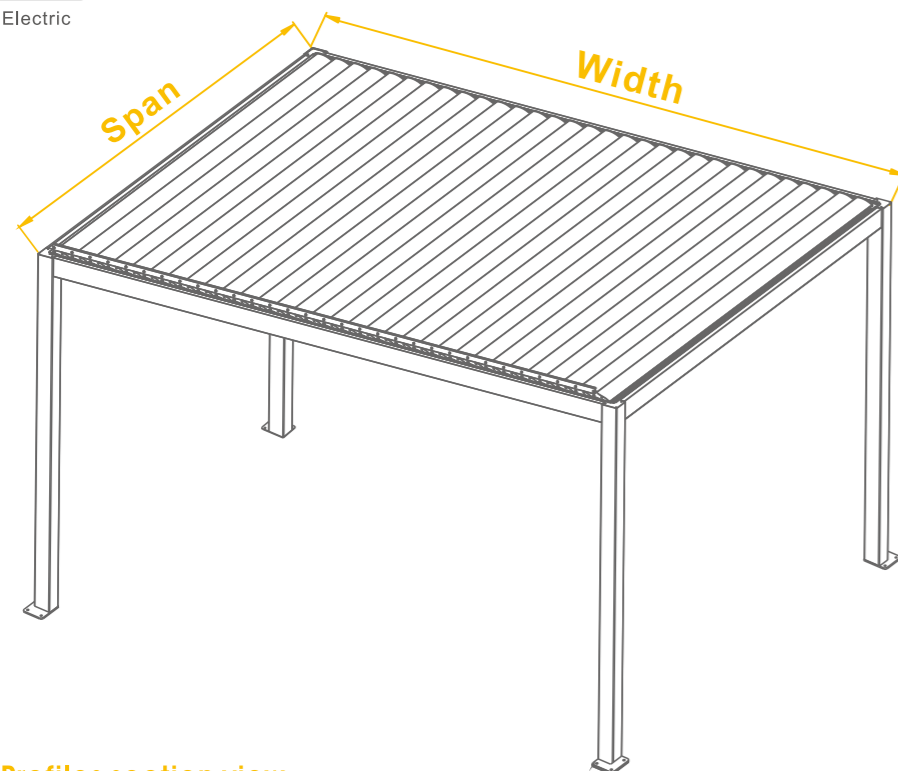

### M170/E170 Standard Size

Width	Span	QTY of post
3m	3m	4
4m	3m	4
5m	3m	4
6m	3m	4
4m	4m	4
5m	4m	4
6m	4m	4

### Standard Color



Dark Gray  
YFC30041  
RAL7043



Matt White  
YFS10001  
RAL9016

### Profiles section view

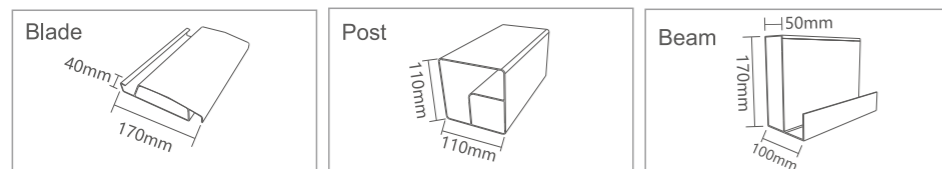

# LOUVERED PERGOLA -CATEGORY

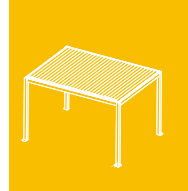

## E220 (Luna)



Electric

Schematic diagram of the maximum dimensions of a single module with 4 posts:

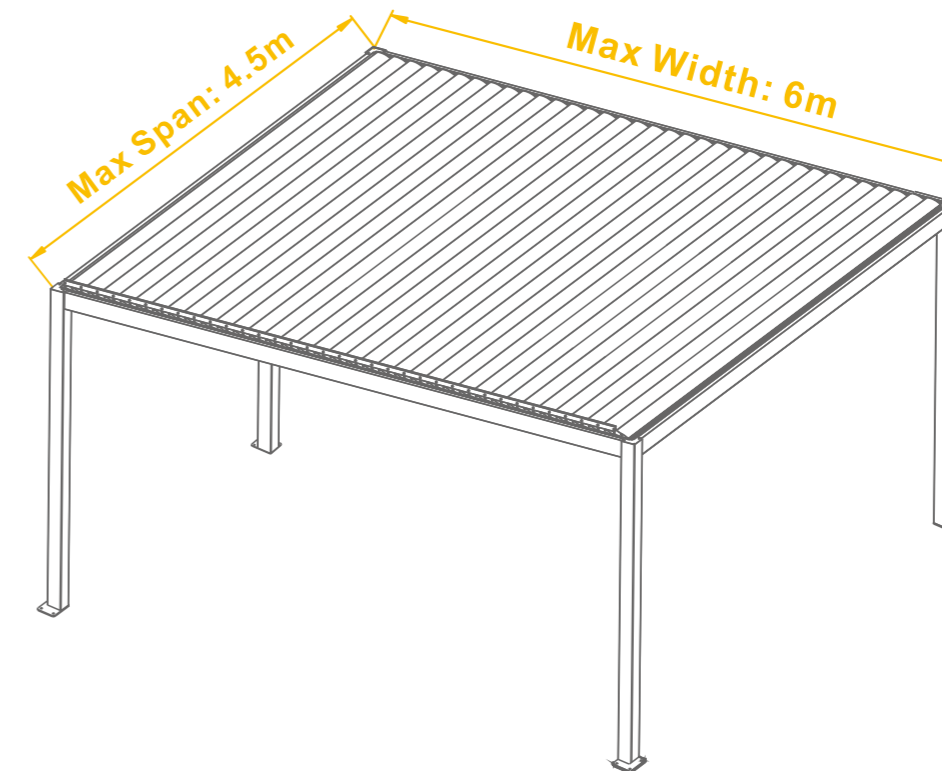

### E220 Standard Size (Custom size available)

Width	Span	QTY of post
3m	3m	4
4m	3m	4
5m	3m	4
6m	3m	4
3m	4m	4
4m	4m	4
5m	4m	4
6m	4m	4

Custom size available:  
the maximum dimensions of  
a single module is 27m<sup>2</sup>

### Standard Color



Dark Gray  
YFC30038  
RAL7016

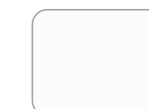

Matt White  
YFS10001  
RAL9016



Matt Brown  
YFS70002  
RAL8014



Matte Black  
YFC80004  
RAL9011

### Profiles section view

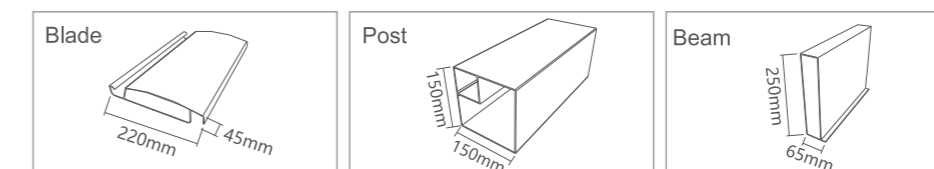



# LOUVERED PERGOLA -CATEGORY

# LOUVERED PERGOLA -DETAILS COMPARISON



## E300 (Wanax)



Electric

Schematic diagram of the maximum dimensions of a single module with 4 posts:

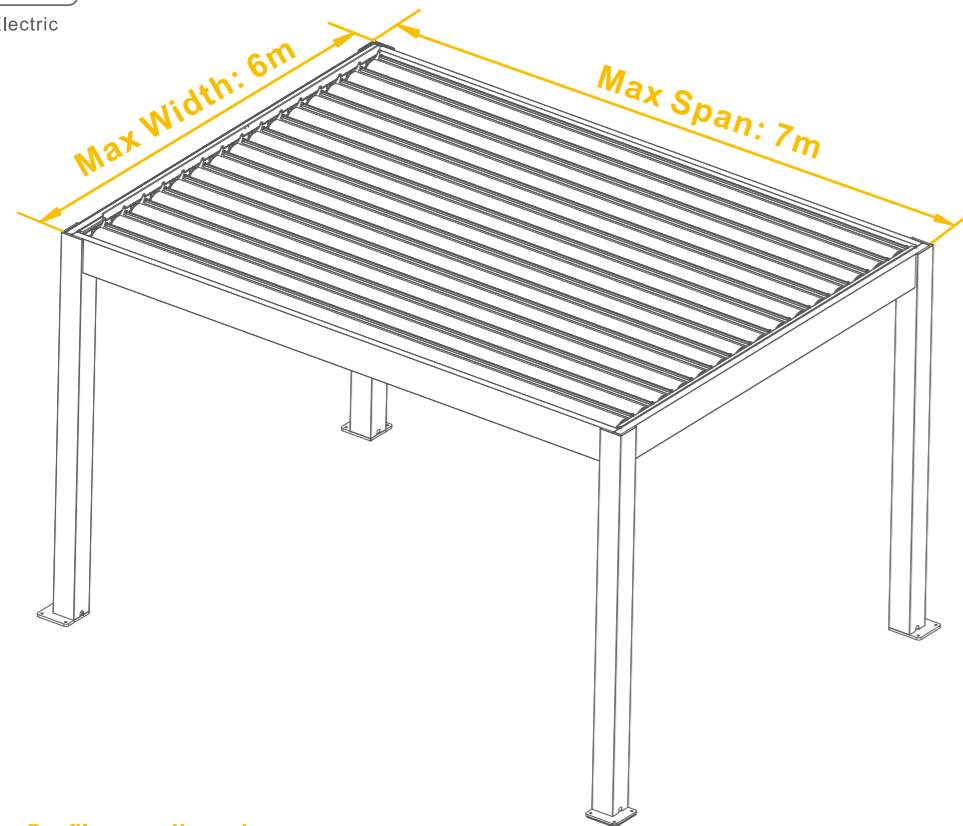

### Profiles section view

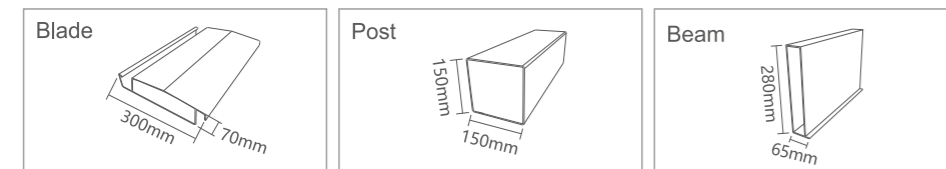

### Standard Color

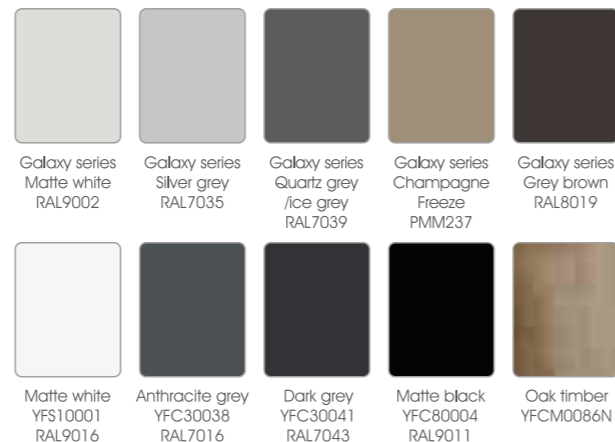

Custom size available: the maximum dimensions of a single module is 42m<sup>2</sup>

M:Manual Control E:Electric Control	Lucida M140S	Stellar M140/E140	Aurora M170/E170	Luna E220	Wanax E300
	140x45x1.2mm	140x35x1.2mm	170x40x1.6mm	220x45x1.8mm	300x70x3.0mm
	130x90x1.5mm	130x90x1.5mm	170x100x2.0mm	250x65x2.0mm	280x50x3.0mm
	100x100x1.8mm	100x100x1.8mm	110x110x2.0mm	150x150x2.3mm	150x150x4.0mm
<b>Blade Advantage- Maximum Span</b>	3m One blade maximum span 3m.	4m One blade maximum span 4m.	4m One blade maximum span 4m.	5m One blade maximum span 5m.	7m One blade maximum span 7m.
<b>Post Advantage</b>	①Wet and dry separation ②Strong structure ③Patent Design				Strong structure, 4mm thickness
<b>Gutter Advantage</b>	Frame and gutter integrated design, Easy install and strong.			With big gutter, fast drainage	
<b>Standard Size (If have quantity, customized available.)</b>	①3x3m ②4x3m ③5x3m ④6x3m (with 6 posts)	①3x3m ②4x3m ③5x3m ④6x3m (with 6 posts) ⑤4x4m	①3x3m ②4x3m ③5x3m ④6x3m ⑤4x4m ⑥5x4m ⑦6x4m	①3x3m ②4x3m ③5x3m ④6x3m ⑤3x4m ⑥4x4m ⑦5x4m ⑧6x4m ⑨Custom size available.	Custom size available.
<b>Blade Advantage- Waterproof Function</b>	With rubber strip in blades,better waterproof performance.				
<b>Wind Load</b>	Beaufort Scale 12 Hurricane				
<b>Snow Load</b>	①0.43m ②85kg/m <sup>2</sup> (Base on louver 3m span)	①0.43m ②120kg/m <sup>2</sup> (Base on louver 3m span)	①0.5m ②135kg/m <sup>2</sup> (Base on louver 4m span)	①0.8m ②190kg/m <sup>2</sup> (Base on louver 4m span)	①1m ②200kg/m <sup>2</sup> (Base on louver 6m span)
<b>Light System</b>	①No Light ②LED Light Strip around the gutter		①No Light ②LED Light Strip built in the blade		①No Light ②Down Light built in the blade or beam

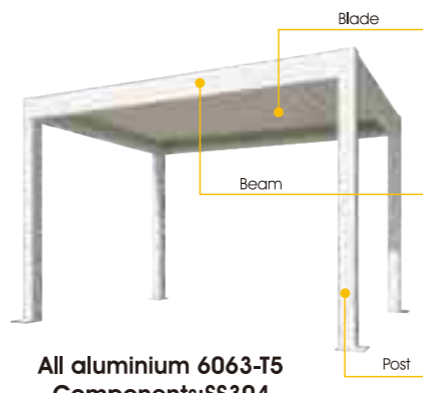

All aluminium 6063-T5  
Components:SS304

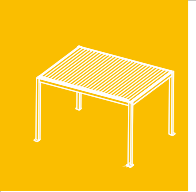

# LOUVERED PERGOLA -SUPPLEMENT

## Zip Screen

- ☀️ An excellent side shading system for pergola.
- ☀️ A perfect match with pergola through the same colour system.
- ☀️ The combination of shading fabric and balancer make sure the opening and closing stability and strong wind resistance.

## Standard Fabric

Light Transmittance: 5%



Dark Grey    White    Black    Black Grey    Brown

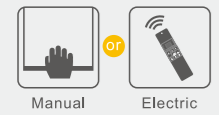

# LOUVERED PERGOLA -SUPPLEMENT

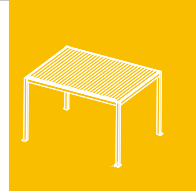

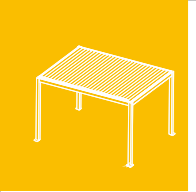

# LOUVERED PERGOLA -SUPPLEMENT

## Aluminium Shutter

- ☀️ Achieve the isolation with the penetration rate of 0.00 for visible light, direct sunlight and UV.
- ☀️ The aerofoil-shaped double-layer louver enhance the bending strength to resistant from external force and achieve the protection.
- ☀️ The aluminium shutter with blades is kind of product possessing functions of shading, protection and decoration.

### Standard Model:



▲ Fixed Shutter



▲ Sliding Shutter



▲ Bi-folding Shutter

### Blade Size:

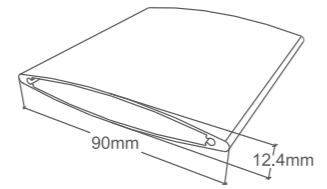

### Standard Color:

Dark Gray YFC30038 RAL7016	Dark Gray YFC30041 RAL7043	Matt White YFS10001 RAL9016	Matt Brown YFS70002 RAL8014	Matte Black YFC80004 RAL9011	OAK YFCM0068N

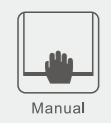

Manual



Wind-resistance	Shading	Light-adjust	Ventilation	Privacy	Heat-insulated	Temperature control	UV resistant

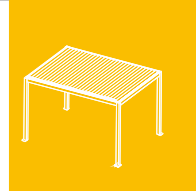

# LOUVERED PERGOLA -SUPPLEMENT

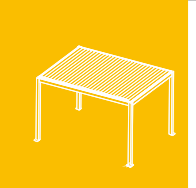

## Electric Slat Louver

- ☀️ For electric control side shading and privacy of the pergola.
- ☀️ This is an High-end version of the louver screen for the side shading of the pergola.
- ☀️ With remote control opening and closing 140 series louver blades and motor build into the frame make the electric aluminium louver more atmospheric and elegant.

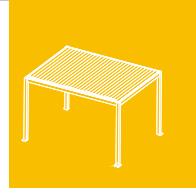
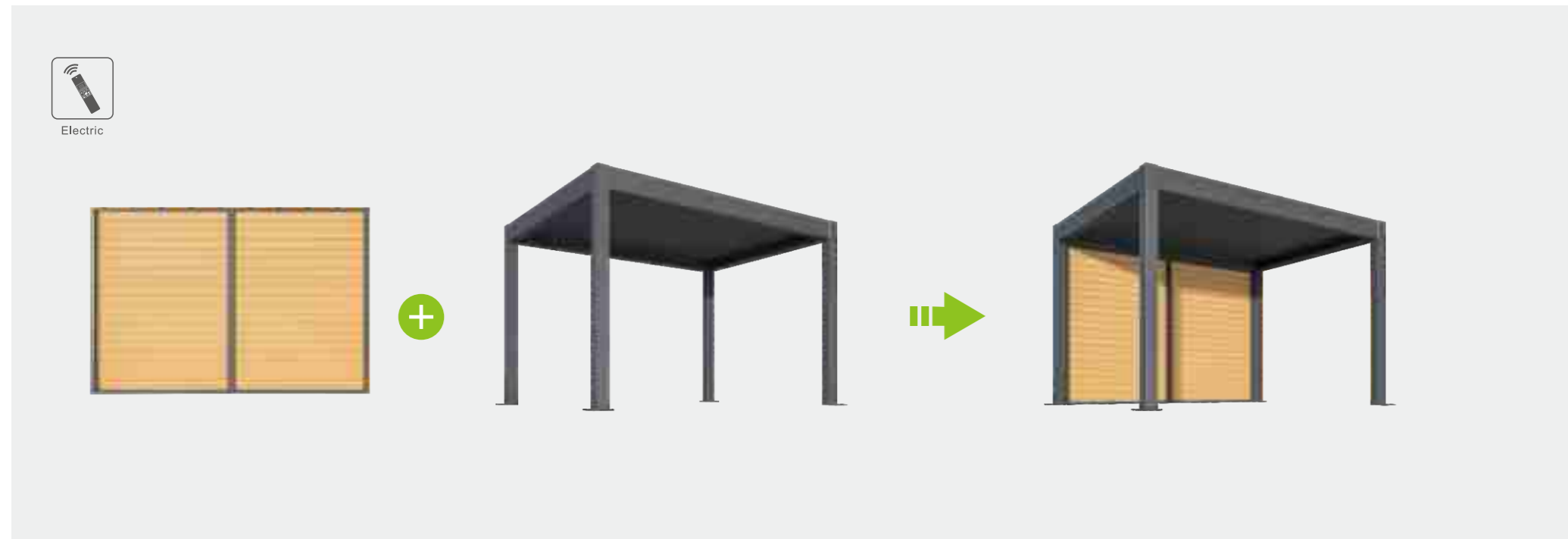

- ☁️ Wind-resistance
- ☀️ Shading
- 🌀 Light-adjust
- 🌬️ Ventilation
- 👁️ Privacy
- 🔥 Heat-insulated
- 🌡️ Temperature control
- 🛡️ UV resistant

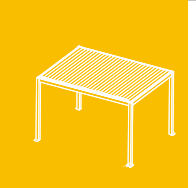

Sidewall Net

- ☀ For prevent the entry of mosquitoes and flying insects while also providing protection against dust and leaves.
- ☀ There are four separate panels with a zipper on each panel of this sidewall net, in order to connect with the adjoining piece.
- ☀ The nylon mesh material of this sidewall net makes enjoying your time under the outdoor pergola easy and pleasurable.



▲ Mosquito Net

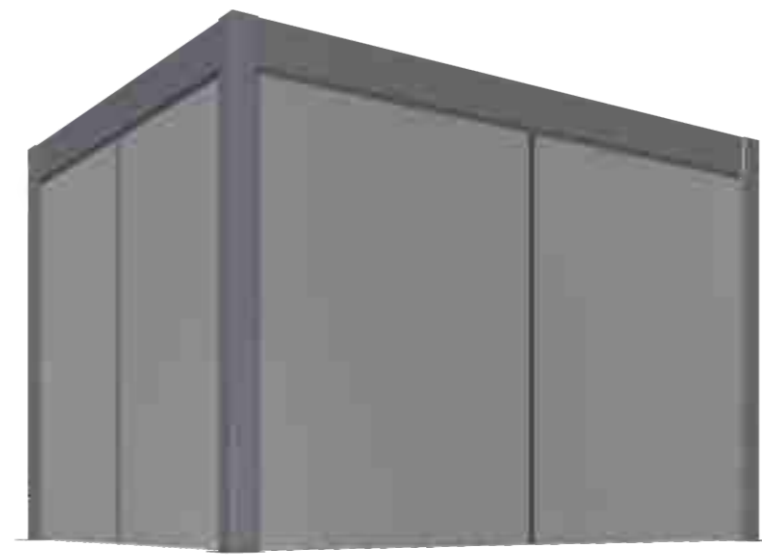

▲ Curtain

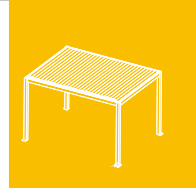

- ☁ Wind-resistance
- ☀ Shading
- 🌀 Ventilation
- 👁 Privacy

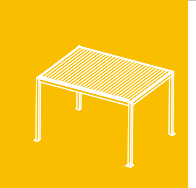

Sheer Curtain

- ☀ For sun protection, UV protection, privacy and decorative of the pergola.
- ☀ Sheer curtain is a great way to make the most of natural light and create a bright and soft outdoor feel and provide privacy and protection from intruding insects and dust.

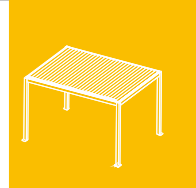

- ☀ Shading
- 🌀 Light-adjust
- 🌬 Ventilation
- 👁 Privacy
- 🛡 UV resistant

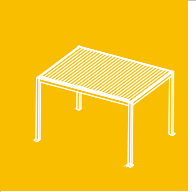

Aluminium Perforated Screen

- ☀ For the partial shading and decoration.
- ☀ Comparing with common metal plates, the decorative aluminum perforated sheets are lighter in weight and higher in strength, especially in changing styles, and are more suitable for decorative sunshade of the pergola.
- ☀ Hole patterns: the round, rectangular, triangle, diamond, hexagonal, cross, slotted. Other hole types according to your drawings or requirements are available.

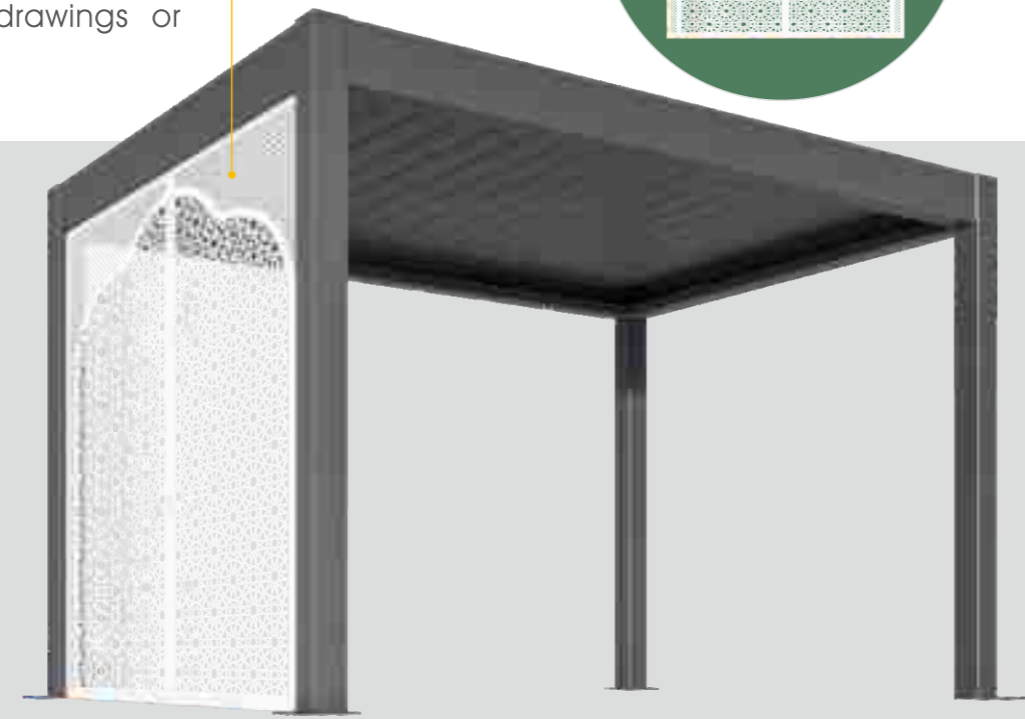
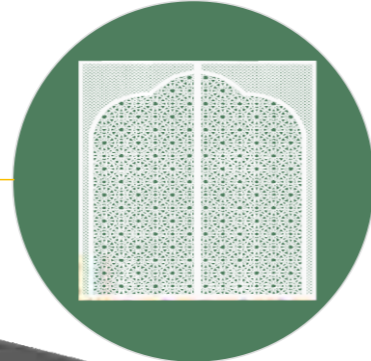

Optional Patterns:

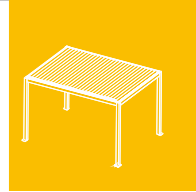
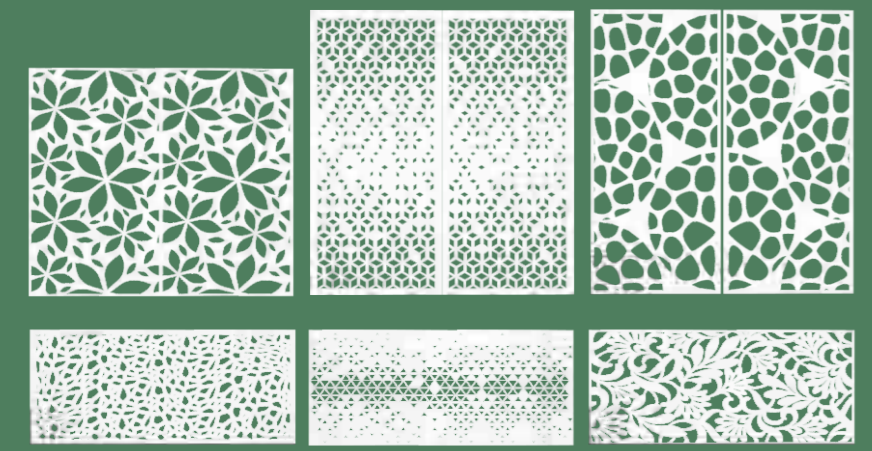

- ☀ Shading
- 🌬 Ventilation
- 👁 Privacy
- 🔥 Heat-insulated



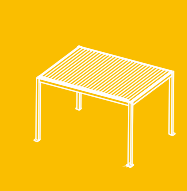

**Sliding Glass Door**

- ☀ To make a pergola to be a private room.
- ☀ We can also combine the aluminium sliding glass door with our pergola for a safer and more private separate room.

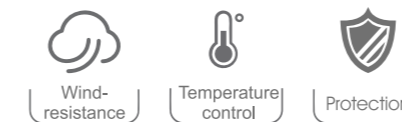
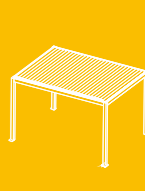

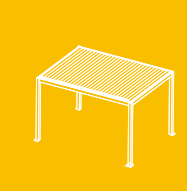

### Fixed Aluminium Screen

- ☀️ A sufficiently durable aluminium structure instead of wood material.
- ☀️ The decorative screen and pergola are integrated into surrounding with practicality and artistry.

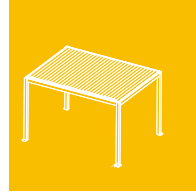
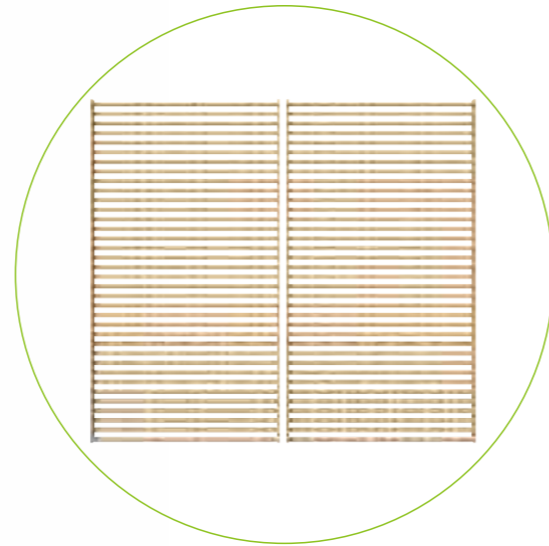

- ☀️ Shading
- 🌬️ Ventilation
- 👁️ Privacy
- 🔥 Heat-insulated

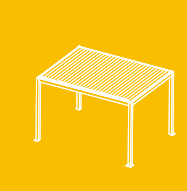

## LOUVERED PERGOLA -LIGHT SYSTEM



### LED light strip around the gutter

For 140 series

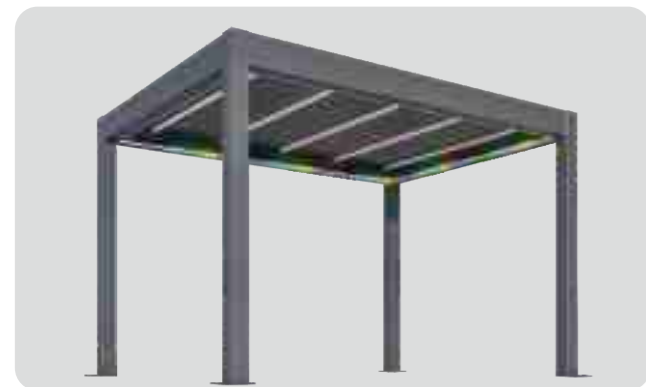

### E220 can be provided of LED light strip with RGB

For 220 series



### LED light strip built in the blade

For 170&220 series

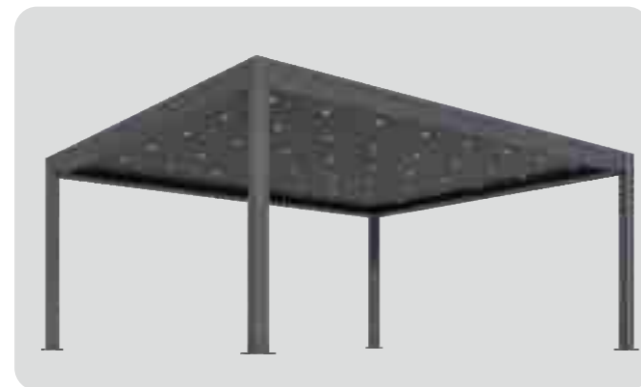

### Down light

For 300 series

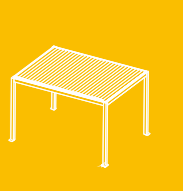

## LOUVERED PERGOLA -ADDITIONAL COMPONENTS



### Rain Wind Sensor

It is a device that automatically senses and detects wind, light, and rain in natural climates, and transmits the detected signals to the receiver to realize automatic closing to protect the electric louvered pergola.



### Solar Panel

By absorbing sunlight and converting it into electrical energy, the control system and lighting system can be electrically controlled without being connected to the power supply.

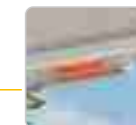

### Heater

The electric heater heats up quickly and the heat is not easy to spread, so it is suitable for heating in the pergola.

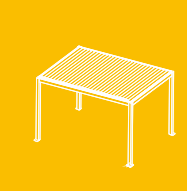

**Freestanding — 4 posts**



**Unilateral Mounting — 2 posts**



**Corner Wall Mounting — 1 post**

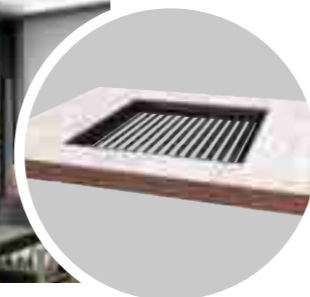

**Roof Standing — No post**

**Out of shape is also available**

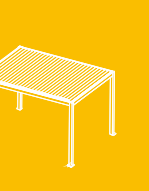

**Conjoined Post Standing — 2 conjoined posts**

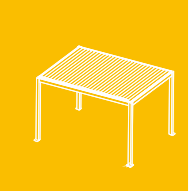

# LOUVERED PERGOLA -PROJECT EXAMPLES



# LOUVERED PERGOLA -PROJECT EXAMPLES

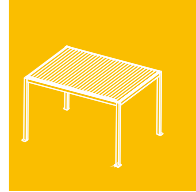

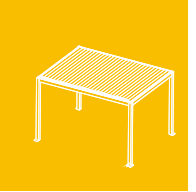

# LOUVERED PERGOLA -PROJECT EXAMPLES



# LOUVERED PERGOLA -PROJECT EXAMPLES

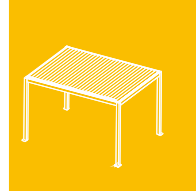

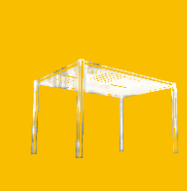

# FIXED PERGOLA -PRODUCT INTRODUCTION

The whole design of the fixed pergola is based on simplicity and lightness. The top of the fixed shed is composed of several aluminum square tube screens. This fixed pergola breaks the mediocrity of the conventional linear layout, it will also bring your outdoor living more bright, leisure and interesting.



### Profiles section view

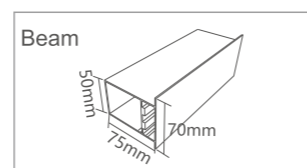
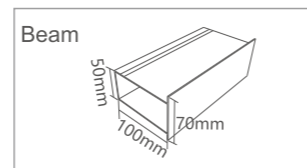
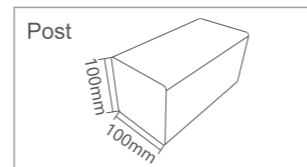
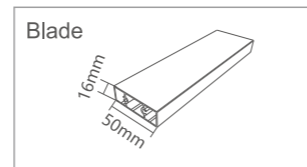

### Standard Color

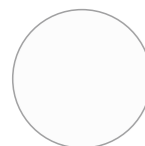

Matt White  
YFS10001  
RAL9016



Dark Gray  
YFC30041  
RAL7043

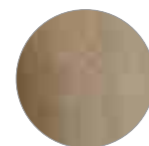

Oak timber  
YFCM0086N

# FIXED PERGOLA -PRODUCT INTRODUCTION





### Sheer Curtain

- ☀ For sun protection, UV protection, privacy and decorative of the pergola.
- ☀ Sheer curtain are a great way to make the most of natural light and create a bright and soft outdoor feel and provide privacy and protection from intruding insects and dust.



- ☀ Shading
- 🌀 Light-adjust
- 🌬 Ventilation
- 👁 Privacy
- 🛡 UV resistant



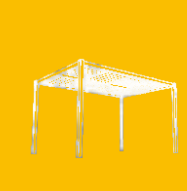

### Aluminium Perforated Screen

- ☀ For the partial shading and decoration.
- ☀ Comparing with common metal plates, the decorative aluminum perforated sheets are lighter in weight and higher in strength, especially in changing styles, and are more suitable for decorative sunshade of the pergola.
- ☀ Hole patterns: the round, rectangular, triangle, diamond, hexagonal, cross, slotted. Other hole types according to your drawings or requirements are available.



- ☀ Shading
- ☪ Ventilation
- 👁 Privacy
- ☹ Heat-insulated



**Shade Sail**

- ☀ For top Shading.
- ☀ Stylish and durable, shade sails instantly boost the shade capabilities of the fixed pergola.
- ☀ Makes fixed pergola more practical by providing UV protection and sun shade.



Shading



UV resistant

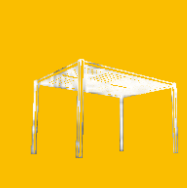

### Outdoor String Light with solar system

- ☀ For decoration.
- ☀ Outdoor string light give off a warm glow and a charming look that's perfect for the cozy feel of a pergola.
- ☀ With solar system, you are no worry about wiring the wires.
- ☀ Try lining the perimeter of your structure with lights, or do a combination of perimeter and zigzag strings of lights.

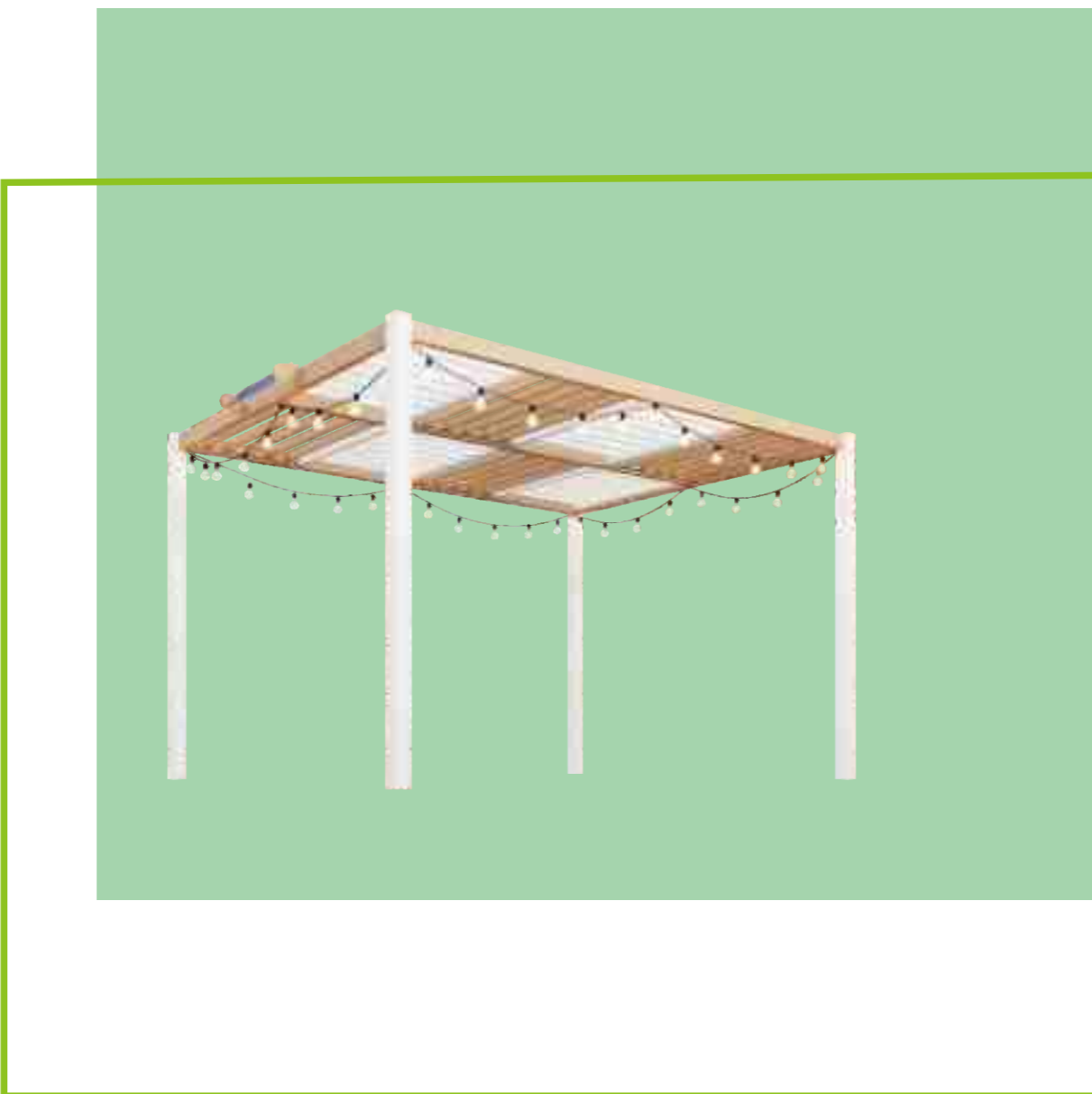

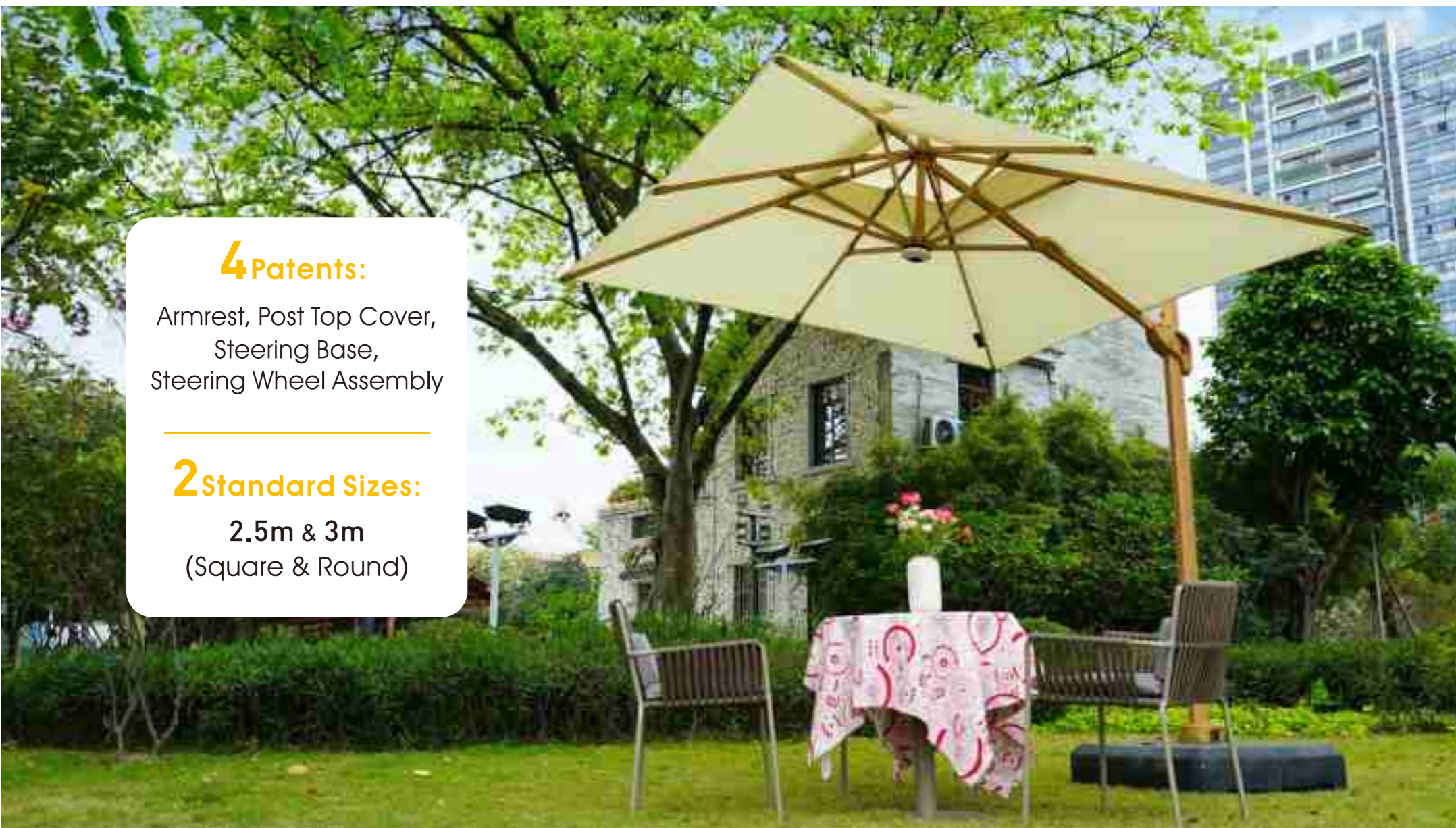

**4 Patents:**  
 Armrest, Post Top Cover,  
 Steering Base,  
 Steering Wheel Assembly

---

**2 Standard Sizes:**  
 2.5m & 3m  
 (Square & Round)

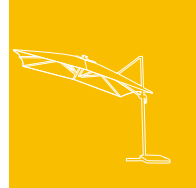

**>> Supporting Facilities**

- Custom Logo on the Fabric

**Fabric**

Imported Fabric (Para)

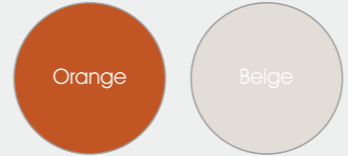

Domestic Fabric



**Aluminium Frame**

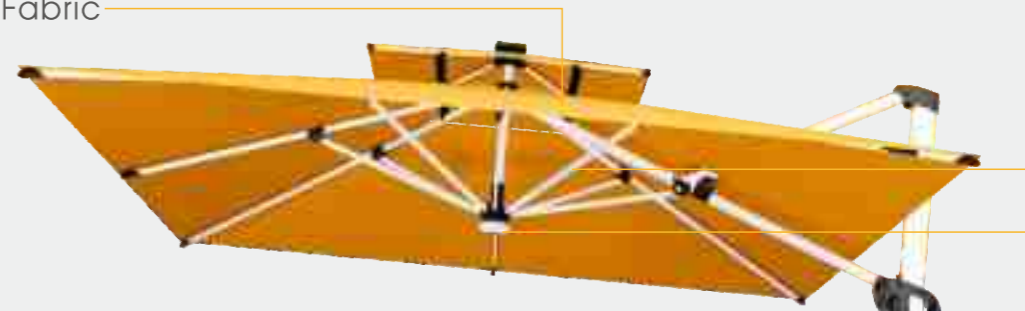

- LED Light System
- Bluetooth Center Light

**Standard Weighted Base**



• Marble Base



• The Tank Base

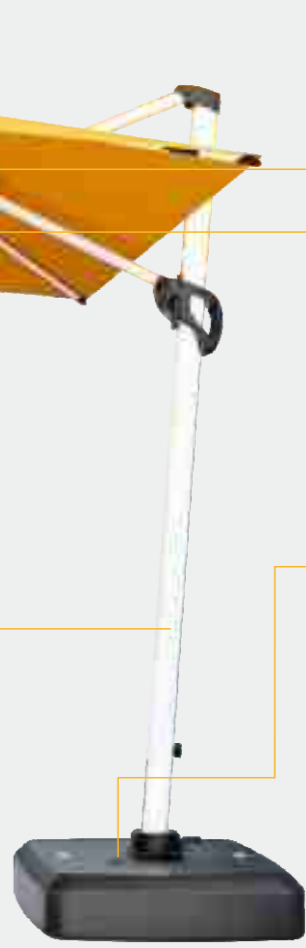

APPLICATION



garden | swimming pool  
restaurant | hotel



The most flexible outdoor sunshade product that shading place can be moved arbitrary.

**Appearance Patent**

- ✓ Armrest
- ✓ Post Top Cover
- ✓ Steering Base

**Utility Model Patent**

- ✓ Steering Wheel Assembly

**Passed Tests**

- ✓ Salt Spray Test    ✓ Drop Test
- ✓ Rain Test

- Materials of screws and rivets: SS304; Material of plastic: PP+15% glass fiber.
- After more than 500 opening and closing tests, it can still be used normally.
- Suggestion: Put away the umbrella when the wind reaches level 5.

» **Material**



Cantilever Umbrella I Square



Cantilever Umbrella I Round

» **Standard Fabric**

**Domestic Fabric:** 240g/m<sup>2</sup> dyed fabric with color fastness level 3, American Standard 1200H.

**Imported Fabric (Para):** 270g/m<sup>2</sup> yarn dyed fabric with color fastness level 7-8, American Standard 2500H.

Production Equipment



40,000+ m<sup>2</sup> Production Plant



**ADD:**  
Xiebian Industrial Park, Dali Town, Nanhai District, Foshan City,  
Guangdong, China

1000+ m<sup>2</sup> Indoor Showroom



1000+ m<sup>2</sup> Outdoor Showroom



 **ADD:**  
6<sup>th</sup> floor, Chengzhi Building, Haiwu Road, Guicheng Street,  
Nanhai District, Foshan City, Guangdong, China



CERTIFICATE OF ENTERPRISE HONOR

- ISO9001
- ISO14001
- BSCI
- CE
- TEST REPORT
- PATENTS

