

窗饰铝型材及配件

Aluminium Curtain Rail Profiles & Components

第二版



佛山市南海永丰铝型材有限公司
FOSHAN CITY NANHAI YONGFENG ALUMINIUM CO.,LTD.

中国广东省佛山市南海区海景路18号
ADD: No.18 Haijing Road, Nanhai District, Foshan City,
Guangdong, China

+86-757-85535511 85565511 85566711

+86-757-85520011 P.C: 528231

yfa@yfa.tm WWW.YFA.TM

窗饰铝型材及配件

Aluminium Curtain Rail Profiles & Components

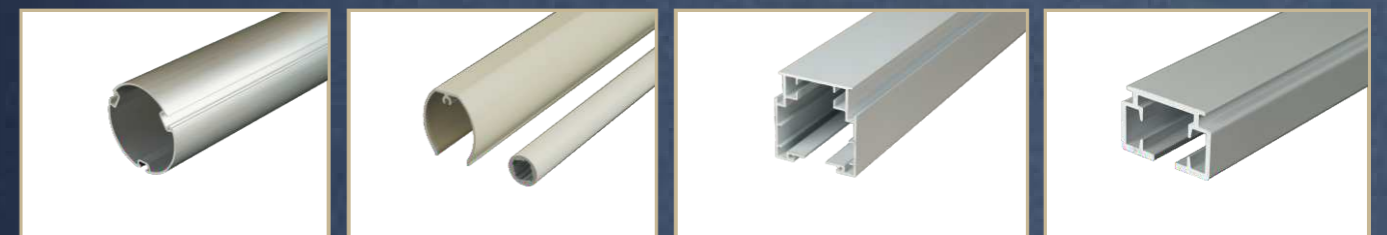

WWW.YFA.TM

 YFA 永豐

深耕者@全球遮阳领域
SINCE 1995



关于永丰 About YFA

永丰(YFA)创建于1995年,是全球窗饰铝型材及配件整体解决方案供应商。根植于中国有色金属产业基地——佛山市南海区大沥镇。

以实干为本作为发展定位的一家民营企业,时至今日700+位伙伴依然坚守着创建之始的初心,在70000+平方米的现代化生产厂房一往无前,为客户、为行业、为社会创造更大价值。

历经28年的国内外市场的风雨洗礼,永丰人不断优化扩大产能,引入多种现代化的生产设备,20条专业窗帘导轨型材生产线配以4条不同性能的粉末喷涂生产线,年产量达到30000+吨。与此同时,分工明确、精准高效的各个深加工后工序,为铝合金外遮阳产品提供最有温度的解决方案。

迈入第29年,尽力做到更好依然是企业的核心价值!我们的团队将继续依附我们的品牌平台,怀着感恩的心携手前行,探索未来更多的未知!



1995 年	70000+ 平方米	20 条	30000+ 吨
公司成立于	现代化生产厂房	专业生产线	年产量
Since 1995	70000+M ² Production Plant	20 Production Lines	30000+ Tons Annual Production

Founded in 1995, Foshan City Nanhai YongFeng Aluminium Co., Ltd. (YFA) has developed into a comprehensive supplier of Aluminium Curtain Rail Profiles and Components. It is located in China Nonferrous Metal Production Base-Dali Town, Nanhai District of Foshan City.

As a private enterprise keeping 'incredible actions' as our development positioning, now YFA has more than 700 employees in a more than 70,000 square meters modern production workshop. We will create greater value for customers, industry, and for our society in this better and better YFA.

By experiencing ups and downs for 28 years, YFA continues to expand the production capacity and introduce advanced extrusion equipments. Nowadays, YFA has 20 professional extrusion lines and 4 powder coating lines with different properties, reaching an annual output of more than 30,000 tons. With clear division and high efficiency, each processing progress is the most temperature foundation of aluminium sunshade product solutions.

Keeping the value of the enterprise of Try My Best To Do and relying on brand platform, YFAers will continue to go forward to explore more unknowns in our 29-year-old!

发展历程 Development Course

1995-2002

- 1995 创立南海市谢边永丰铝型材厂
Founded Nanhai City Xiebian Yongfeng Aluminium Profile Factory .
- 1996 创建“永丰”牌铝材
Created “YONGFENG” Aluminium Brand.
- 2002 转为佛山市南海永丰铝型材有限公司
Restructured into Foshan City Nanhai YONGFENG Aluminium Co., Ltd.

2011-2014

- 2011 成为央视网中国铝型材黄金展位合作伙伴
Became the partner of Gold Booth for China Aluminium Profiles of CCTV.com.
- 2014 成为国家标准局铝合金护栏封面目录的负责人
Became the Head Partner of the Aluminium Fencing Catalogue of National Standard Bureau.

2003-2009

- 2003 获得国家质量技术监督局颁发“采用国际标准产品标志证书”
Awarded with “Adopting International Standard Product Marking Certificate” by State Bureau of Quality and Technical Supervision.
- 2005 获取ISO 9001质量管理体系认证并持续至今
Passed the ISO 9001 Quality Management System Certification.
- 2009 获取ISO 14001环境管理体系认证并持续至今
Passed the ISO 14001 Environmental Management System Certification.

2015-2021

- 佛山市南海区年度纳税超1000万元企业
More than 10 Million Annual Tax of Foshan Nanhai Enterprises

2017-2019

- 2017 成为《建筑室内窗饰产品通用技术要求》国家标准参编单位
Became national standard participated units of "The general technical requirements of building indoor tracery product".
- 2018 成获得改革开放40周年窗饰遮阳行业40周年杰出贡献奖
Received the award of outstanding contribution to the 40th anniversary of reform and opening up.
- 2019 成为中国建筑装饰装修材料协会建筑遮阳材料分会副会长单位
Became the vice president of building shading materials branch of China building decoration materials association.

2020-2023

- 2020 成为南海制造业全国隐形冠军
Became the national hidden champion of Nanhai manufacturing.
- 2021 获得企业标准“领跑者”证书
Obtained the certification of ENTERPRISE STANDARD FORERUNNER.
- 2022 成为大湾区遮阳出口企业联盟会员单位
Become a member of Export Shading Enterprise Alliance in Greater Bay Area
- 2023 荣升省级专精特新中小企业
Became Technologically Advanced Small and Medium-sized Enterprises

尽力做到更好
Keep trying our best to do.



▶ 生产车间
YEA'S WORKSHOP



4条粉末喷涂生产线
4 Powder Coating Lines



20条专业窗帘型材挤压生产线
20 Extrusion Lines



▶ 目录 CONTENTS



01

卷帘系列
Roller Blind

01-20



02

柔纱帘/斑马帘
&香格里拉帘系列
Zebra Blind

21-32



03

百叶帘系列
Venetian Blind

33-36



04

蜂巢帘系列
Honeycomb Blind

37-44

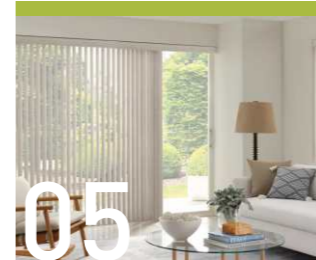

05

垂直帘系列
Vertical Blind

45-48



06

罗马帘系列
Roman Blind

49-50



07

铝芯
Tilt Rod

51-54

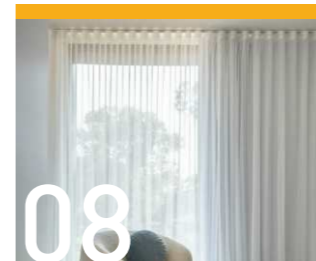

08

轨道系列
Curtain Track

55-58

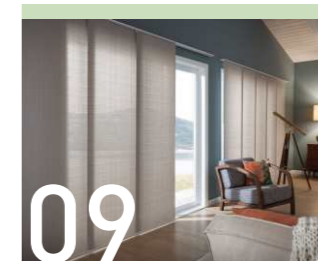

09

屏风帘系列
Panel Track

59-62

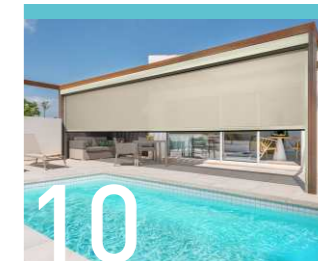

10

边槽系列
Side Track

63-66

01

Roller Blind

卷帘系列

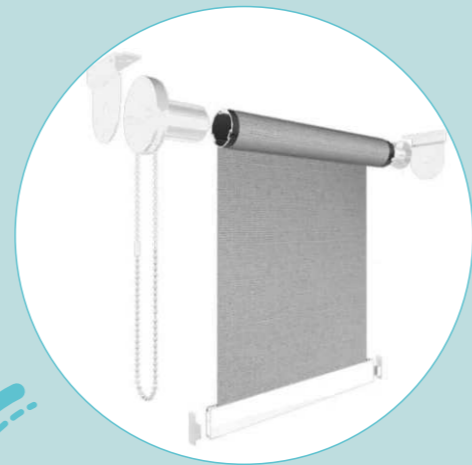

卷帘管

Roller Tube

28管-弧形单槽管型材及配件-110131

28mm Roller Tube With Components

卷帘系列
Roller Blind



0.45mm壁厚

Thickness: 0.45mm

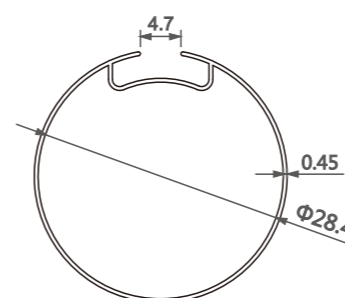

型号/Item No.-110131-0.45
米重/Weight-0.126kg/m

0.6mm壁厚

Thickness: 0.6mm

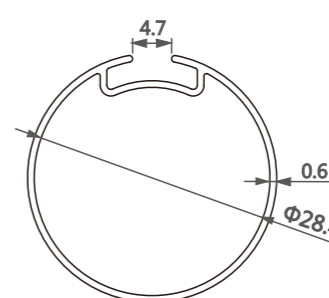

型号/Item No.-110131-0.6
米重/Weight-0.168kg/m

0.8mm壁厚

Thickness: 0.8mm

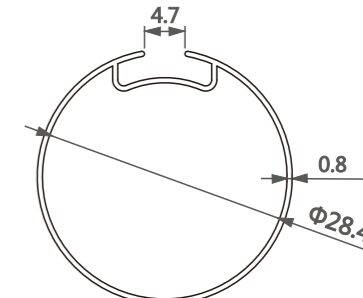

型号/Item No.-110131-0.8
米重/Weight-0.226kg/m

1.0mm壁厚

Thickness: 1.0mm

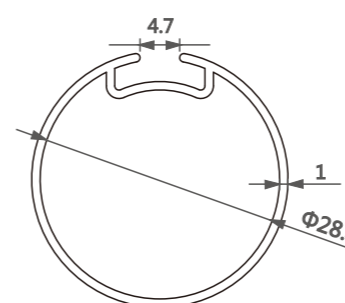

型号/Item No.-110131-1.0
米重/Weight-0.285kg/m

1.2mm壁厚

Thickness: 1.2mm

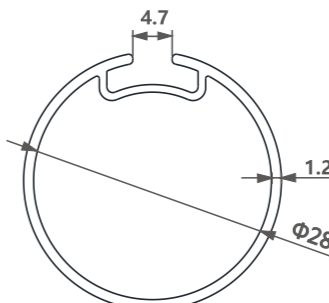

型号/Item No.-110131-1.2
米重/Weight-0.331kg/m



28TC-1



28TC-2



28TC-3

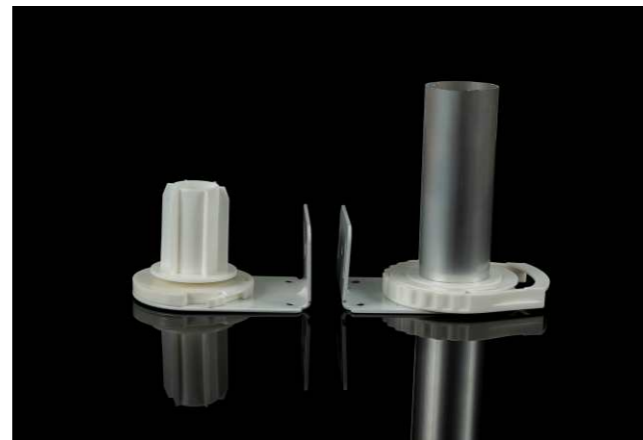

28TC-4

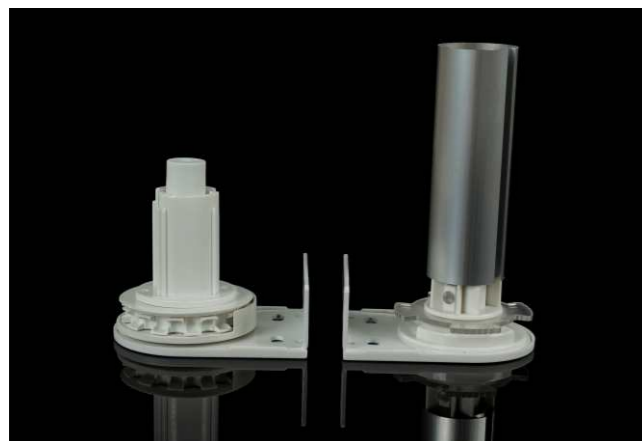

28TC-5



0.6mm壁厚

Thickness: 0.6mm

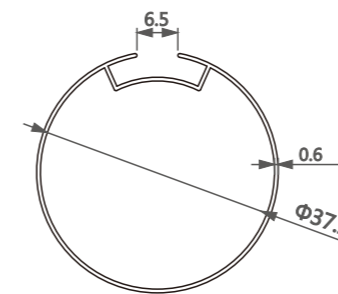

型号/Item No.-110123-0.6
米重/Weight-0.218kg/m

0.8mm壁厚

Thickness: 0.8mm

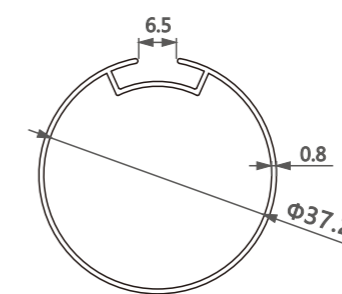

型号/Item No.-110123-0.8
米重/Weight-0.292kg/m

1.0mm壁厚

Thickness: 1.0mm

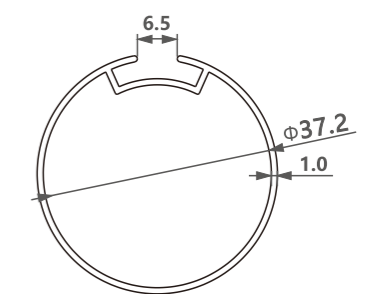

型号/Item No.-110123-1.0
米重/Weight-0.366kg/m

1.2mm壁厚

Thickness: 1.2mm

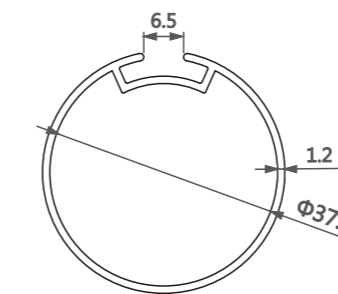

型号/Item No.-110123-1.2
米重/Weight-0.440kg/m

1.5mm壁厚

Thickness: 1.5mm

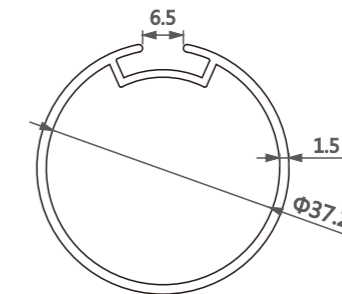

型号/Item No.-110123-1.5
米重/Weight-0.53kg/m

卷帘管
Roller Tube

38管-制头控制系统
38mm Roller Tube Control Mechanism Set

卷帘管
Roller Tube

38管-平口单槽管型材-1116884
38mm Roller Tube

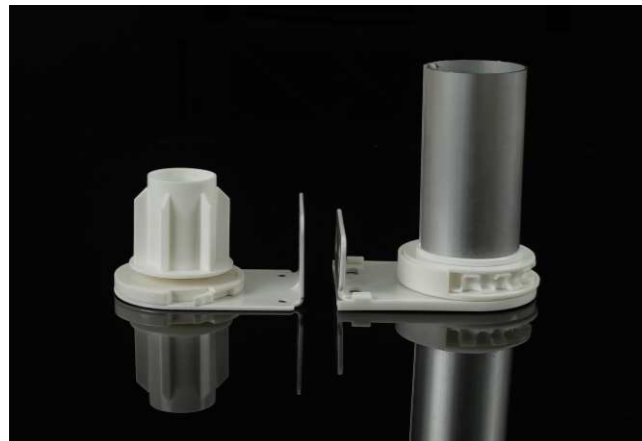

38TC-1



38TC-2



38TC-3



38TC-4



38TC-5



0.45mm壁厚

Thickness: 0.45mm

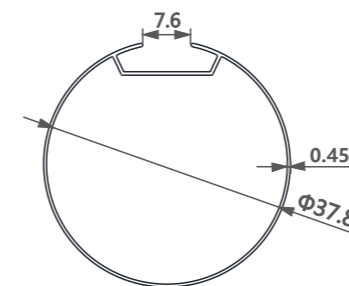

型号/Item No.-1116884-0.45
米重/Weight-0.171kg/m

0.6mm壁厚

Thickness: 0.6mm

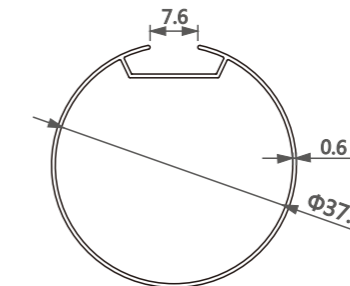

型号/Item No.-1116884-0.6
米重/Weight-0.217kg/m

0.8mm壁厚

Thickness: 0.8mm

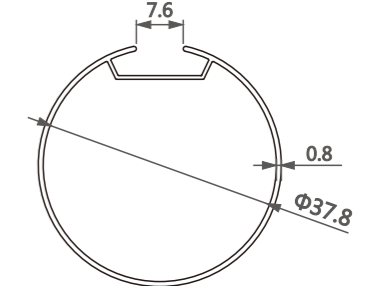

型号/Item No.-1116884-0.8
米重/Weight-0.28kg/m

1.0mm壁厚

Thickness: 1.0mm

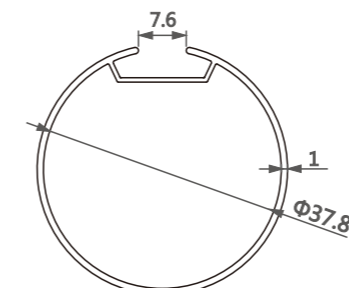

型号/Item No.-1116884-1.0
米重/Weight-0.35kg/m

1.2mm壁厚

Thickness: 1.2mm

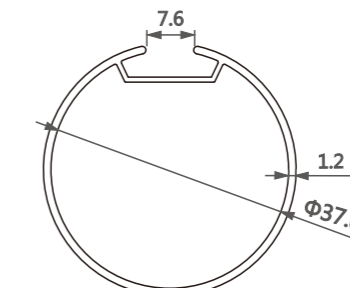

型号/Item No.-1116884-1.2
米重/Weight-0.419kg/m

卷帘管 | 38管-弧形双槽管型材及配件-1116577
Roller Tube | 38mm Roller Tube With Double Track

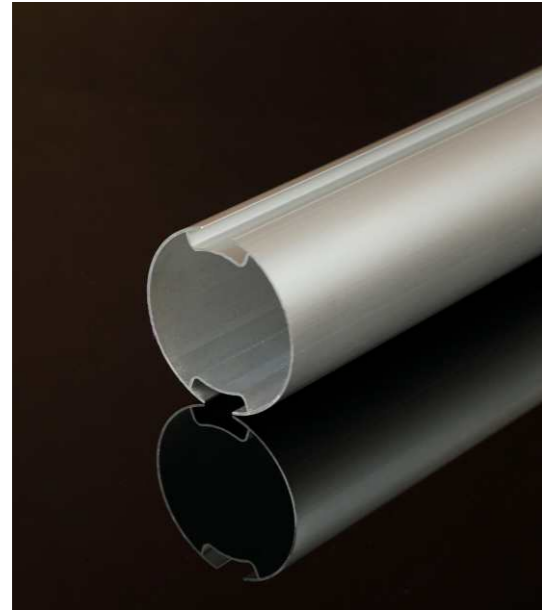

0.7mm壁厚

Thickness: 0.7mm

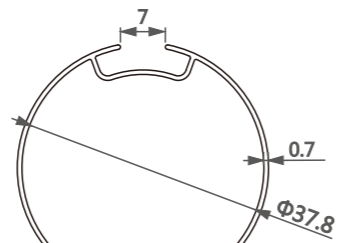

型号/Item No.-1116577
米重/Weight-0.279kg/m

1.0mm壁厚

Thickness: 1.0mm

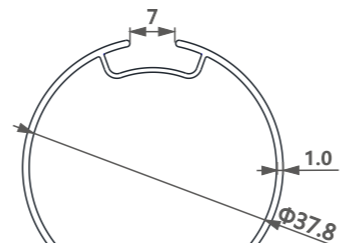

型号/Item No.-1116577-1.0
米重/Weight-0.369kg/m

卷帘管 | 50管-弧形单槽管型材-110192
Roller Tube | 50mm Roller Tube



卷帘管 | 制头控制系统
Roller Tube | Control mechanism set



38DTC-1

1.2mm壁厚

Thickness: 1.2mm

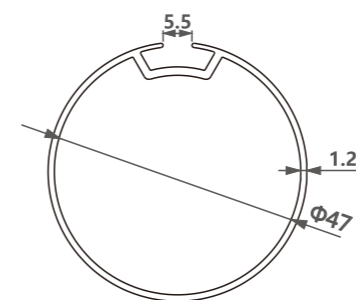

型号/Item No.-110192-1.2
米重/Weight-0.555kg/m

1.6mm壁厚

Thickness: 1.6mm

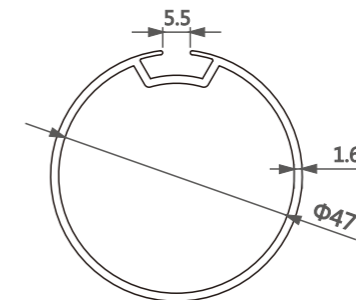

型号/Item No.-110192
米重/Weight-0.710kg/m

卷帘管 | 50管-圆管型材-6110382
Roller Tube | 50mm Round Tube



1.5mm壁厚

Thickness: 1.5mm

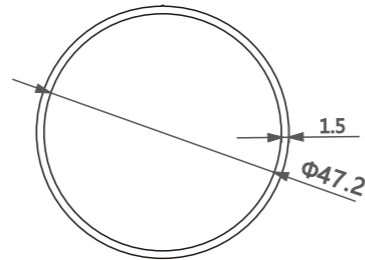

型号/Item No.-6110382
米重/Weight-0.627kg/m

卷帘管 | 63管-三槽管型材-110121
Roller Tube | 63mm Roller Tube with three tracks



1.33mm壁厚

Thickness: 1.33mm

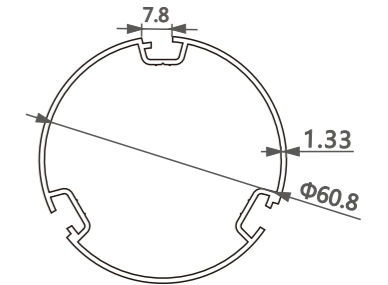

型号/Item No.-110121-1.33
米重/Weight-0.862kg/m

卷帘管 | 55管-弧形单槽管型材-1116333
Roller Tube | 55mm Roller Tube

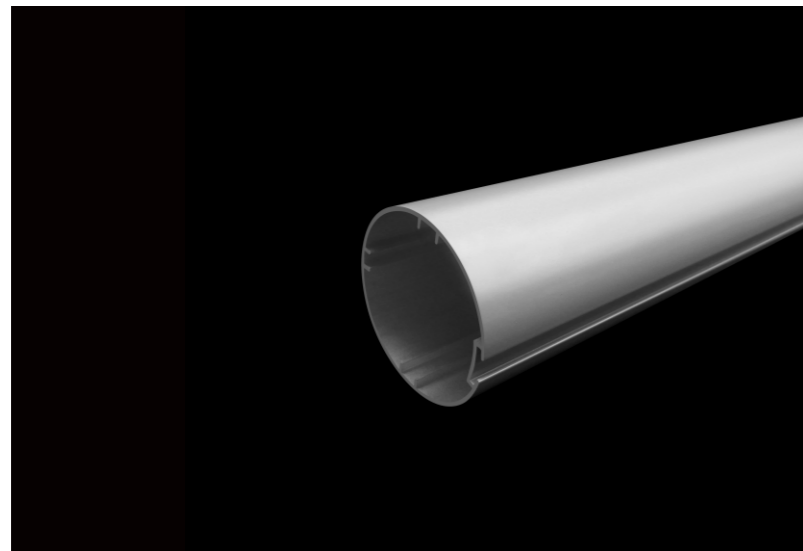

1.2mm壁厚

Thickness: 1.2mm

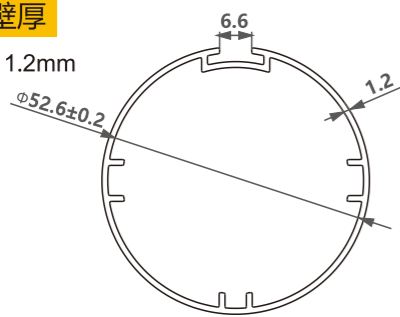

型号/Item No.-1116333-1.2
米重/Weight-0.652kg/m

1.5mm壁厚

Thickness: 1.5mm

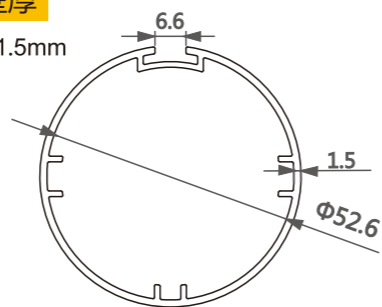

型号/Item No.-1116333-1.5
米重/Weight-0.798kg/m

卷帘管 | 85管-三槽管型材-11161248
Roller Tube | 85mm Roller Tube with three tracks



2.0mm壁厚

Thickness: 2.0mm

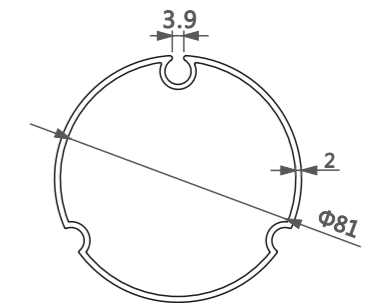

型号/Item No.-11161248
米重/Weight-1.554kg/m

卷帘管型材
Roller Tube Profile

卷帘管型材
Roller Tube Profile

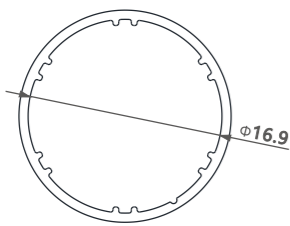

型号/Item No.-1118480
米重/Weight-0.129kg/m

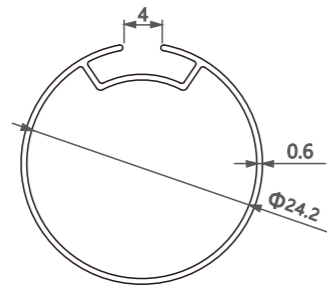

型号/Item No.-1118423
米重/Weight-0.146kg/m

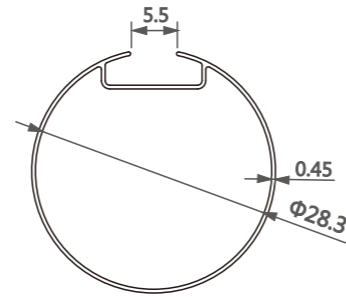

型号/Item No.-11181076-0.45
米重/Weight-0.125kg/m

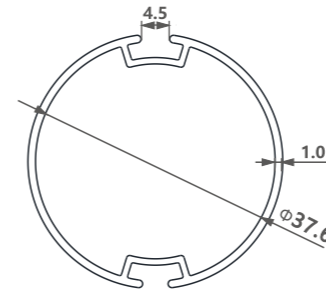

型号/Item No.-1118974
米重/Weight-0.447kg/m

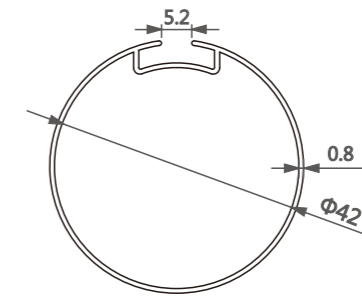

型号/Item No.-1110104
米重/Weight-0.326kg/m

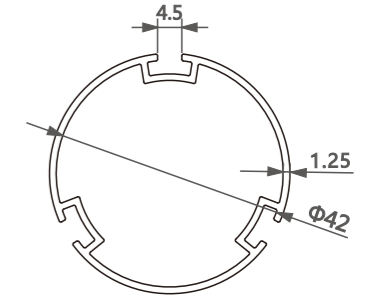

型号/Item No.-1118206
米重/Weight-0.564kg/m

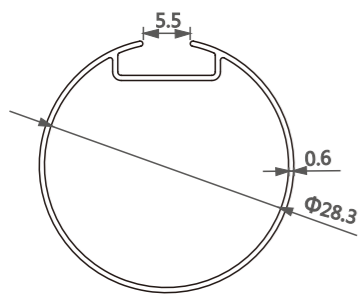

型号/Item No.-11181076-0.6
米重/Weight-0.167kg/m

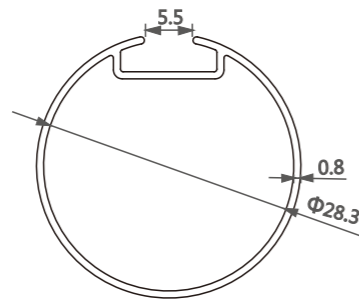

型号/Item No.-11181076-0.8
米重/Weight-0.224kg/m

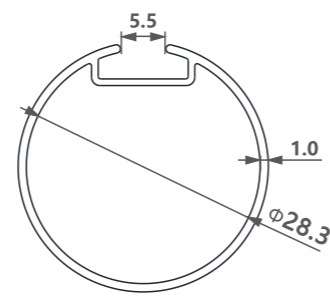

型号/Item No.-11181076-1.0
米重/Weight-0.272kg/m

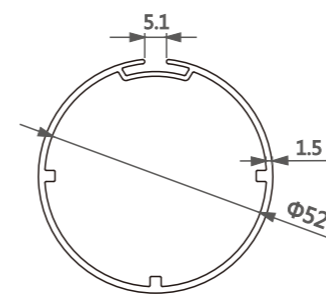

型号/Item No.-1116848
米重/Weight-0.758kg/m

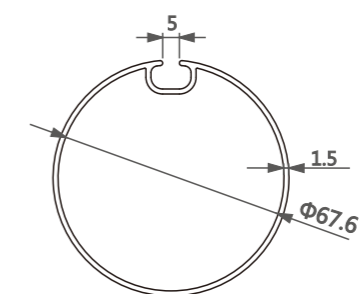

型号/Item No.-1118197
米重/Weight-0.970kg/m

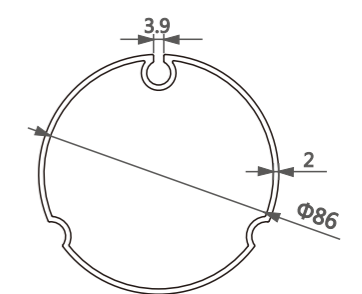

型号/Item No.-1116945
米重/Weight-1.658kg/m

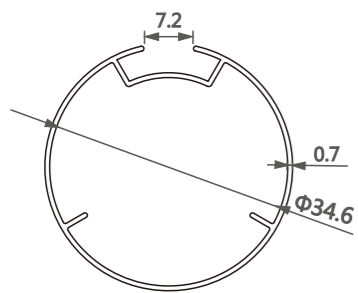

型号/Item No.-1110110
米重/Weight-0.246kg/m

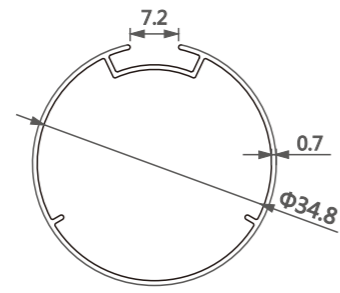

型号/Item No.-1110179
米重/Weight-0.239kg/m

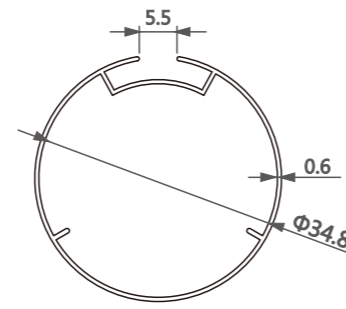

型号/Item No.-1110166
米重/Weight-0.215kg/m

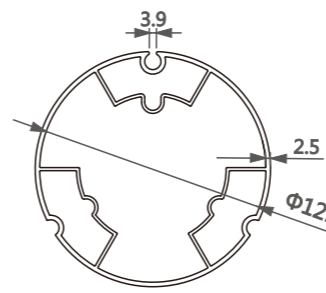

型号/Item No.-11181170
米重/Weight-4.205kg/m

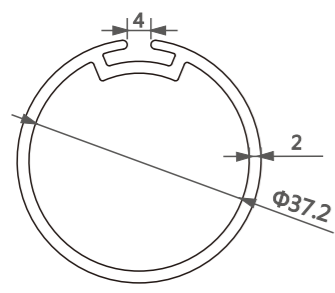

型号/Item No.-1118900
米重/Weight-0.734kg/m

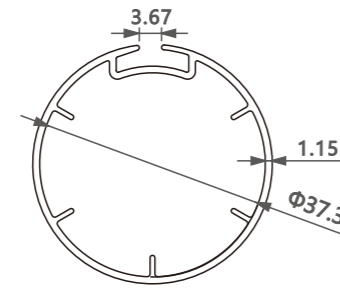

型号/Item No.-1118446
米重/Weight-0.457kg/m

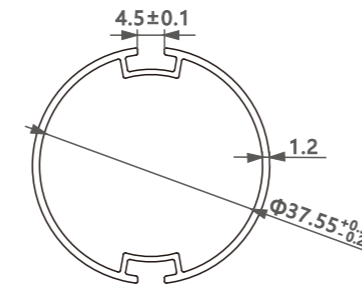

型号/Item No.-1118186
米重/Weight-0.441kg/m

卷帘下杆
Roller Blind Bottom Rail

15单开口下杆型材-110116
15mm Bottom Rail Profile



0.7mm壁厚

Thickness: 0.7mm

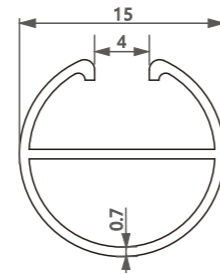

型号/Item No.-110116
米重/Weight-0.106kg/m

卷帘下杆
Roller Blind Bottom Rail

20双开口下杆型材及配件-110115
20mm Bottom Rail Profile With Components



0.8mm壁厚

Thickness: 0.8mm

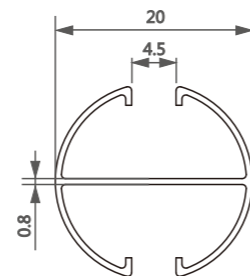

型号/Item No.-110115-0.8
米重/Weight-0.16kg/m

▼端盖 End Caps



卷帘下杆
Roller Blind Bottom Rail

子弹下杆型材及配件-1907195
Bottom Rail Profile With Components



0.7mm壁厚

Thickness: 0.7mm

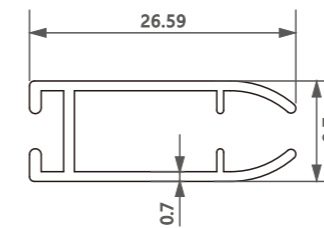

型号/Item No.-1907195-0.7
米重/Weight-0.146kg/m

1.0mm壁厚

Thickness: 1.0mm

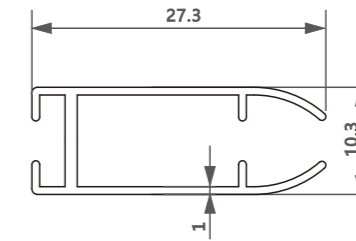

型号/Item No.-1907195-1.0
米重/Weight-0.199kg/m

▼端盖 End Caps



卷帘下杆
Roller Blind Bottom Rail

小号下杆型材及配件-11161608
Bottom Rail Profile With Components



1.0mm壁厚

Thickness: 1.0mm

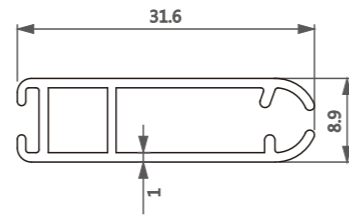

型号/Item No.-11161608
米重/Weight-0.231 kg/m

▼端盖 End Caps



EC608-1



EC608-2

卷帘下杆
Roller Blind Bottom Rail

大号下杆型材及配件-0901253
Bottom Rail Profile With Components



1.0mm壁厚

Thickness: 1.0mm

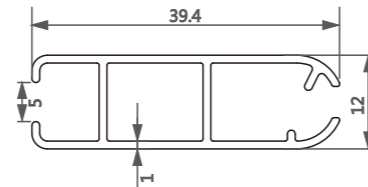

型号/Item No.-0901253
米重/Weight-0.297 kg/m

▼端盖 End Caps



EC253-1



EC253-2



EC253-3

卷帘下杆
Roller Blind Bottom Rail

3.5公分下杆(屏风帘下杆)型材及配件-1907243
Bottom Rail Profile With Components



0.7mm壁厚

Thickness: 0.7mm

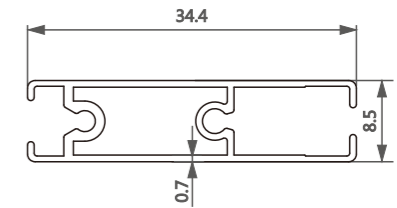

型号/Item No.-1907243-0.7
米重/Weight-0.201 kg/m

▼端盖 End Caps



1.0mm壁厚

Thickness: 1.0mm

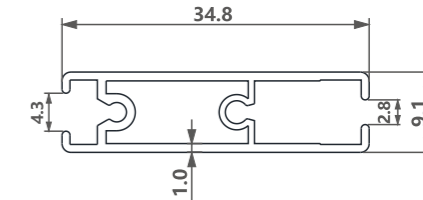

型号/Item No.-1907243-1.0
米重/Weight-0.26 kg/m

卷帘下杆
Roller Blind Bottom Rail

重型下杆型材及配件-1116649
Bottom Rail Profile With Components



1.3mm壁厚

Thickness: 1.3mm

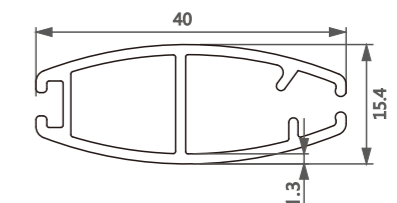

型号/Item No.-1116649
米重/Weight-0.401 kg/m

▼端盖 End Caps



卷帘下杆
Roller Blind Bottom Rail

牵引杆型材-11161132
Bottom Rail Profile

卷帘下杆型材
Roller Blind Bottom Rail Profile



1.4mm壁厚

Thickness: 1.4mm

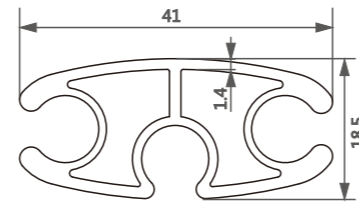

型号/Item No.-11161132
米重/Weight-0.611kg/m

卷帘下杆型材
Roller Blind Bottom Rail Profile

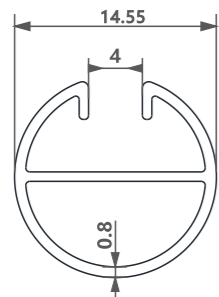

型号/Item No.-11162217
米重/Weight-0.122kg/m

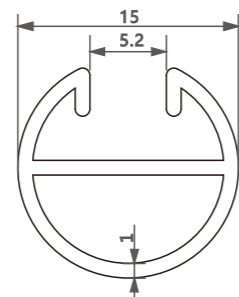

型号/Item No.-1116099
米重/Weight-0.152kg/m

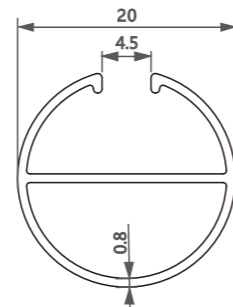

型号/Item No.-110117
米重/Weight-0.166kg/m

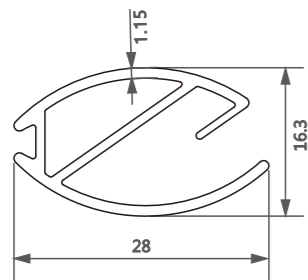

型号/Item No.-1118147
米重/Weight-0.267kg/m

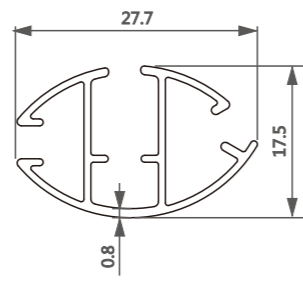

型号/Item No.-11181356
米重/Weight-0.224kg/m

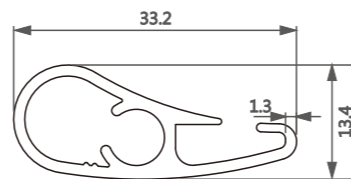

型号/Item No.-1118695
米重/Weight-0.298kg/m

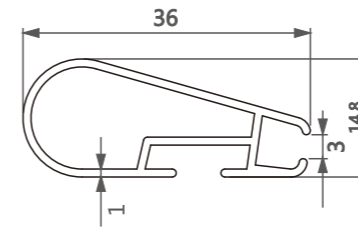

型号/Item No.-11181615
米重/Weight-0.271kg/m

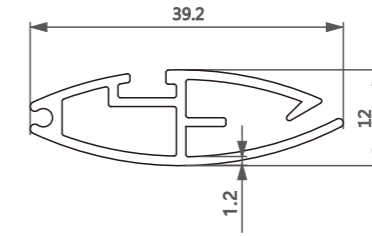

型号/Item No.-1116433
米重/Weight-0.331kg/m

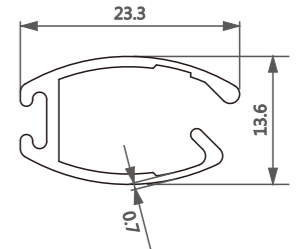

型号/Item No.-191071
米重/Weight-0.190kg/m

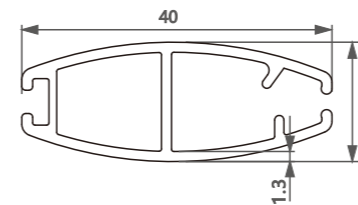

型号/Item No.-1116649-1.3
米重/Weight-0.401kg/m

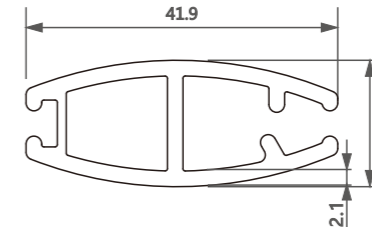

型号/Item No.-1116337-2.1
米重/Weight-0.646kg/m

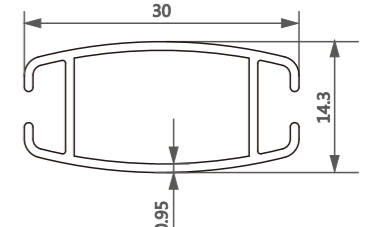

型号/Item No.-11161181
米重/Weight-0.234kg/m

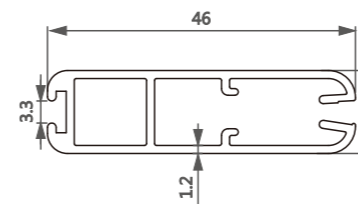

型号/Item No.-0900420
米重/Weight-0.455kg/m

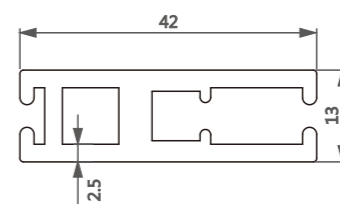

型号/Item No.-190713
米重/Weight-0.812kg/m

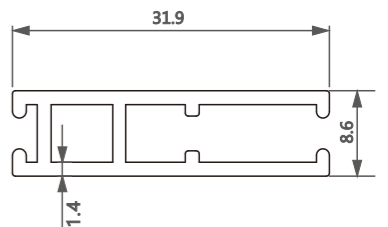

型号/Item No.-190718
米重/Weight-0.311kg/m

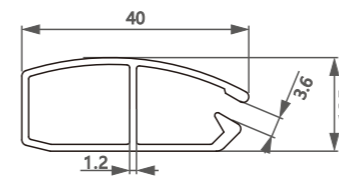

型号/Item No.-110172
米重/Weight-0.382kg/m

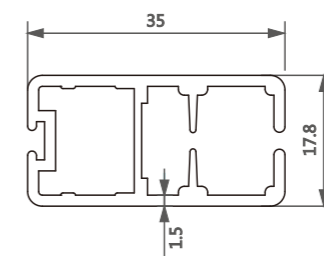

型号/Item No.-4278291
米重/Weight-0.53kg/m

卷帘上杆型材
Roller Blind Top Rail Profile

卷帘上杆型材
Roller Blind Top Rail Profile

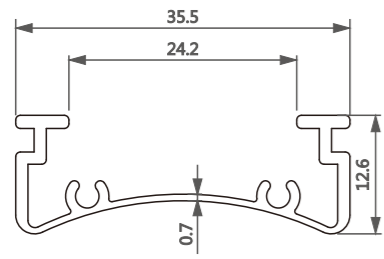

型号/Item No.-110127
米重/Weight-0.228kg/m

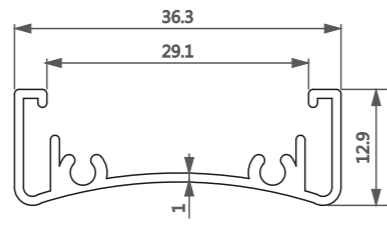

型号/Item No.-110181
米重/Weight-0.256kg/m

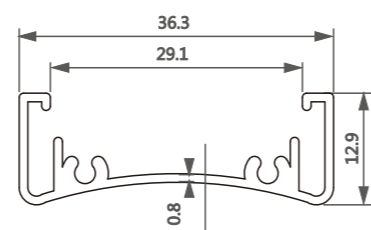

型号/Item No.-110163
米重/Weight-0.263kg/m

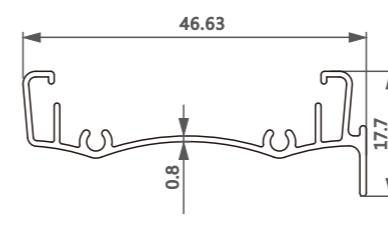

型号/Item No.-111344
米重/Weight-0.251kg/m

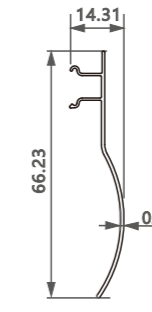

型号/Item No.-111345
米重/Weight-0.197kg/m

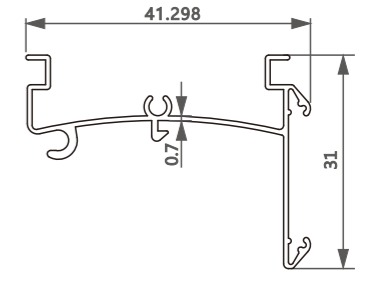

型号/Item No.-111368
米重/Weight-0.242kg/m

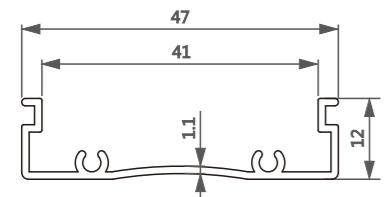

型号/Item No.-110113
米重/Weight-0.265kg/m

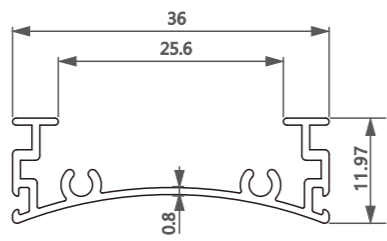

型号/Item No.-1116051
米重/Weight-0.217kg/m

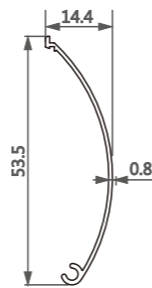

型号/Item No.-1116052
米重/Weight-0.150kg/m

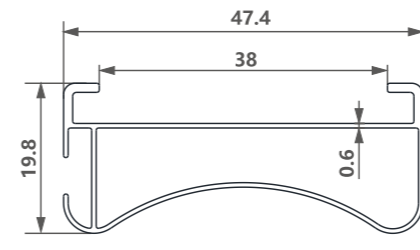

型号/Item No.-11182512
米重/Weight-0.267kg/m

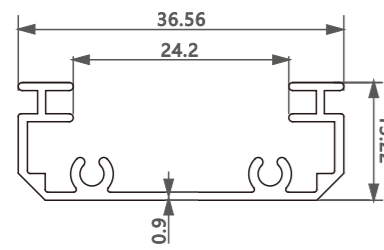

型号/Item No.-110128
米重/Weight-0.259kg/m

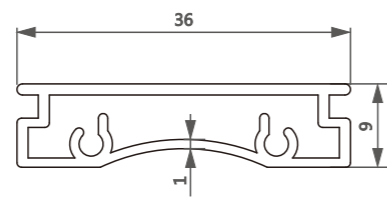

型号/Item No.-111301
米重/Weight-0.318kg/m

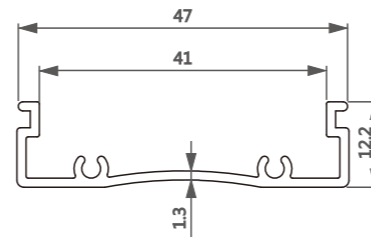

型号/Item No.-1118983
米重/Weight-0.31kg/m

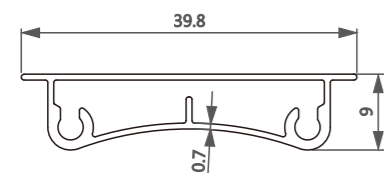

型号/Item No.-1116475
米重/Weight-0.218kg/m

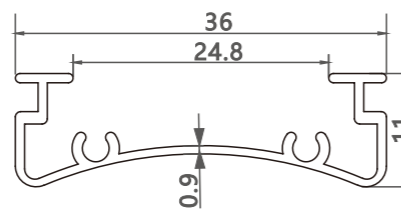

型号/Item No.-110165
米重/Weight-0.189kg/m

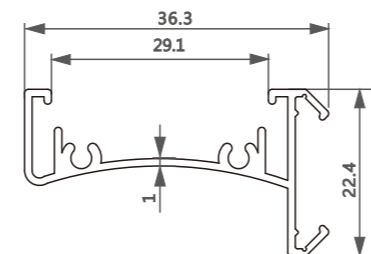

型号/Item No.-1116191
米重/Weight-0.316kg/m

02

Zebra Blind

柔纱帘/斑马帘&香格里拉帘



罩壳 | 插片罩型材及配件-1118888 Cassette | Cassette Profile with Components



0.85mm壁厚
Thickness: 0.85mm

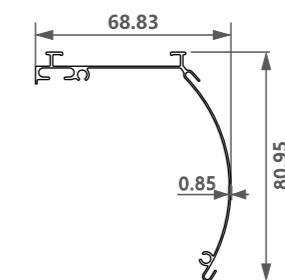

型号/Item No.-1118888-0.85
米重/Weight-0.475kg/m

0.9mm壁厚
Thickness: 0.9mm

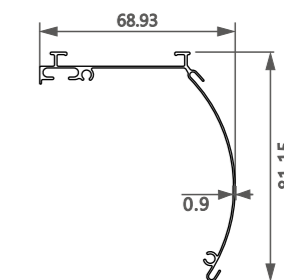

型号/Item No.-1118888-0.9
米重/Weight-0.497kg/m

▼ 封盖 End Caps



罩壳 | 罩壳型材及配件-11181012 Cassette | Cassette Profile with Components



1.0mm壁厚
Thickness: 1.0mm

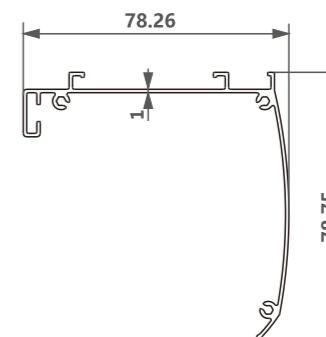

型号/Item No.-11181012
米重/Weight-0.65kg/m

▼ 封盖 End Caps



Zebra Blind
柔纱帘/斑马帘&香格里拉帘

罩壳 | 罩壳型材-11181442
Cassette | Cassette Profile

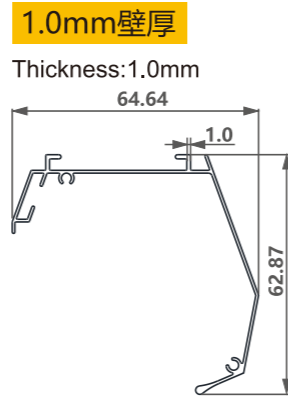

型号/Item No.-11181442
米重/Weight-0.370kg/m

罩壳 | 罩壳型材-11161602
Cassette | Cassette Profile

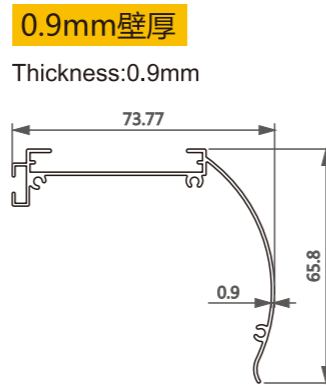

型号/Item No.-11161602
米重/Weight-0.484kg/m

罩壳 | 罩壳型材及配件-11181738
Cassette | Cassette Profile with Components

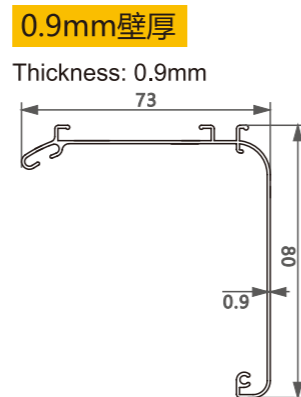

型号/Item No.-11181738
米重/Weight-0.505kg/m

▼ 封盖 End Caps



罩壳 | 罩壳型材-11161347
Cassette | Cassette Profile

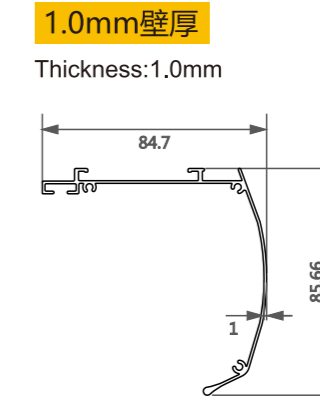
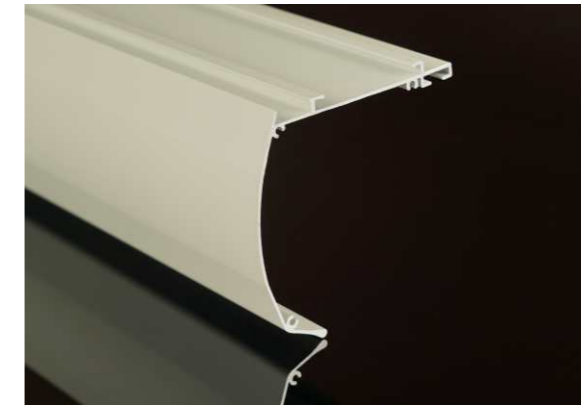

型号/Item No.-11161347
米重/Weight-0.672kg/m

罩壳 | 罩壳型材-11182494
Cassette | Cassette Profile

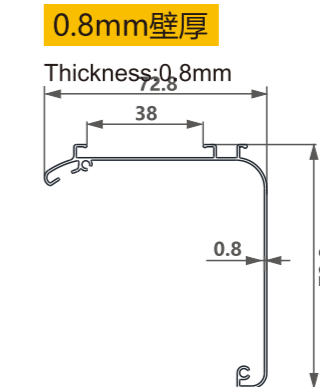

型号/Item No.-11182494
米重/Weight-0.449kg/m

罩壳 | 罩壳型材-11182493
Cassette | Cassette Profile

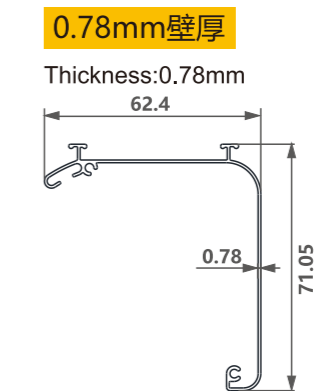

型号/Item No.-11182493
米重/Weight-0.397kg/m

罩壳 | 方形罩壳型材及配件-11182449

Cassette | Cassette Profile with Components



1.0mm壁厚

Thickness: 1.0mm

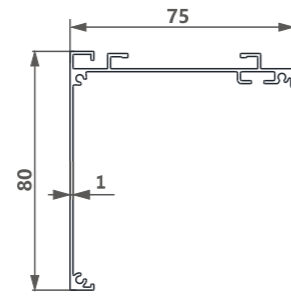

型号/Item No.-11182449
米重/Weight-0.673kg/m

封盖 End Caps



罩壳型材

Cassette Profile

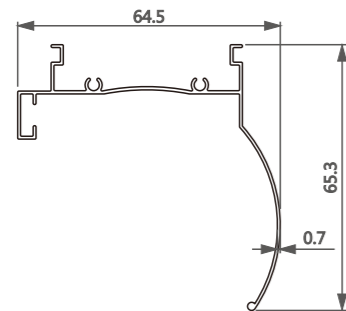

型号/Item No.-11161039
米重/Weight-0.359kg/m

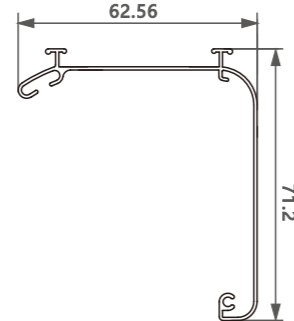

型号/Item No.-11181739
米重/Weight-0.426kg/m

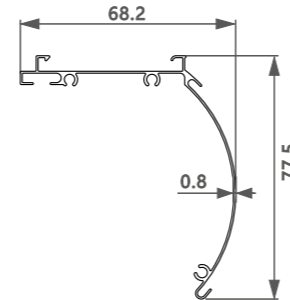

型号/Item No.-11161027
米重/Weight-0.468kg/m

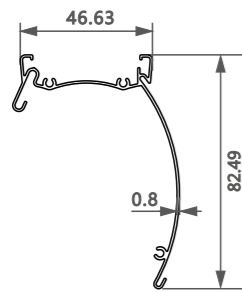

型号/Item No.-1118384
米重/Weight-0.484kg/m

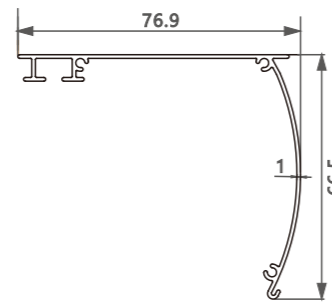

型号/Item No.-1116292
米重/Weight-0.496kg/m

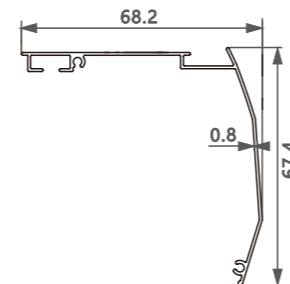

型号/Item No.-11181500
米重/Weight-0.363kg/m

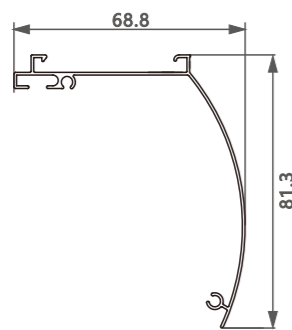

型号/Item No.-11181266
米重/Weight-0.415kg/m

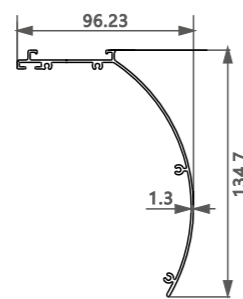

型号/Item No.-11181857
米重/Weight-0.982kg/m

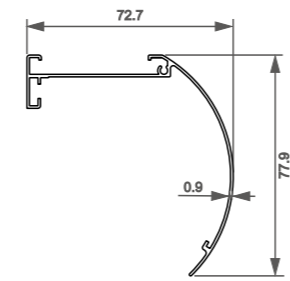

型号/Item No.-1118555
米重/Weight-0.48kg/m

罩壳型材

Cassette Profile

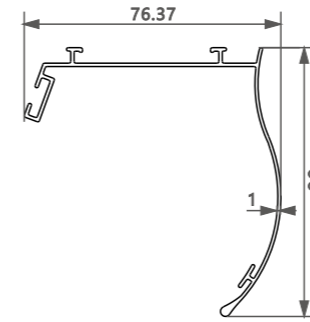

型号/Item No.-11181373
米重/Weight-0.563kg/m

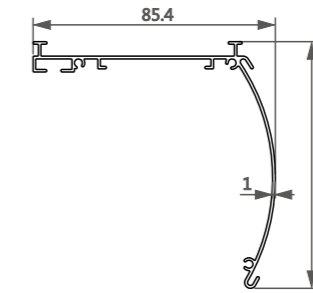

型号/Item No.-1116955
米重/Weight-0.618kg/m

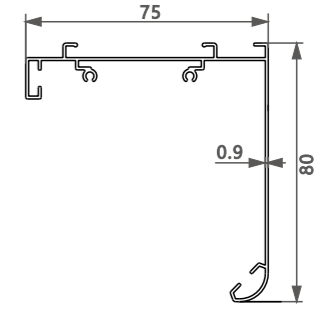

型号/Item No.-11182095
米重/Weight-0.598kg/m

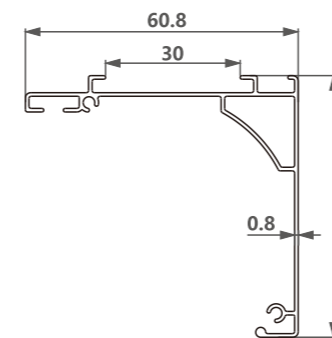

型号/Item No.-11162226
米重/Weight-0.433kg/m

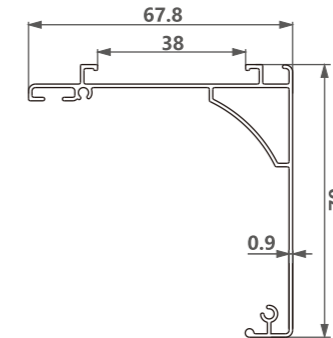

型号/Item No.-11162225
米重/Weight-0.563kg/m

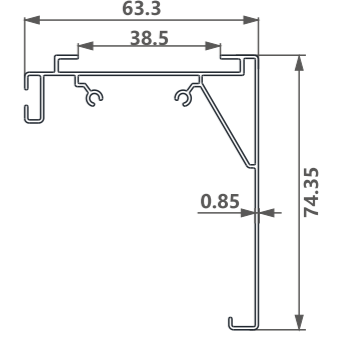

型号/Item No.-11182510
米重/Weight-0.585kg/m

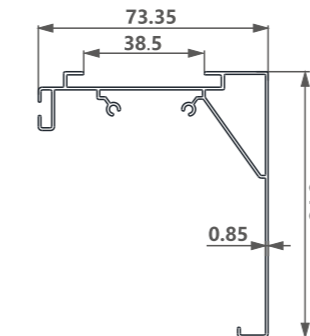

型号/Item No.-11182511
米重/Weight-0.651kg/m

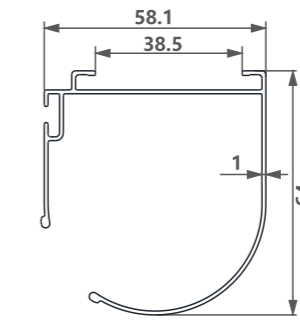

型号/Item No.-11182536
米重/Weight-0.607kg/m

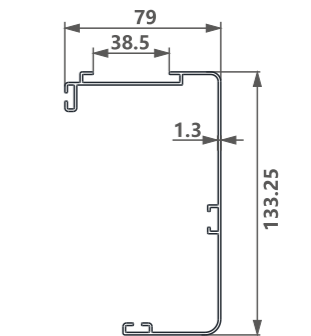

型号/Item No.-11182535
米重/Weight-1.175kg/m

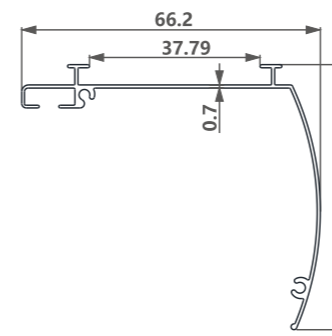

型号/Item No.-11181050
米重/Weight-0.32kg/m

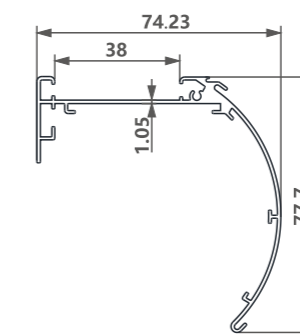

型号/Item No.-1116541
米重/Weight-0.711kg/m

柔纱帘/斑马帘&香格里拉帘
Zebra Blind Bottom Rail

柔纱帘 (斑马帘) 下轨型材及配件-11161348
Zebra Blind Bottom Rail With Components



1.0mm壁厚

Thickness: 1.0mm

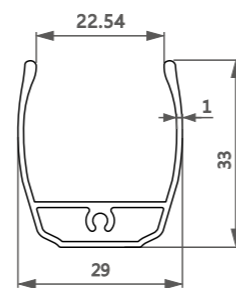

型号/Item No.-11161348
米重/Weight-0.351kg/m

▼ 封盖 End Caps



柔纱帘/斑马帘&香格里拉帘
Zebra Blind Bottom Rail

柔纱帘 (斑马帘) 下轨型材-11161600
Zebra Blind Bottom Rail



0.9mm壁厚

Thickness: 0.9mm

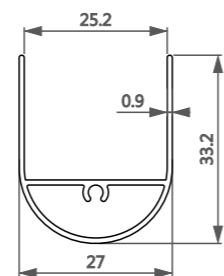

型号/Item No.-11161600
米重/Weight-0.274kg/m

柔纱帘/斑马帘&香格里拉帘
Zebra Blind Bottom Rail

柔纱帘 (斑马帘) 下轨型材及配件-11181443
Zebra Blind Bottom Rail With Components

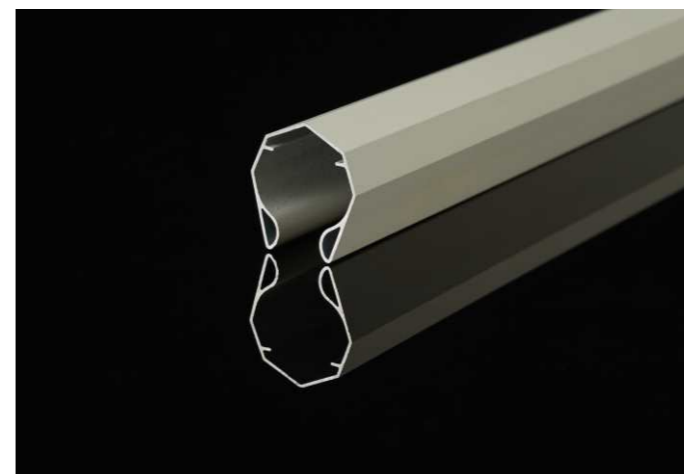

0.7mm壁厚

Thickness: 0.7mm

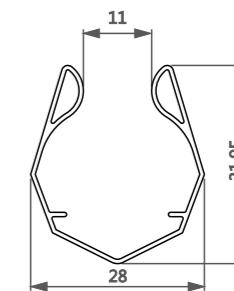

型号/Item No.-11181443
米重/Weight-0.217kg/m

▼ 封盖 End Caps



柔纱帘/斑马帘&香格里拉帘
Zebra Blind Bottom Rail

柔纱帘 (斑马帘) 下轨型材-11181555
Zebra Blind Bottom Rail



1.0mm壁厚

Thickness: 1.0mm

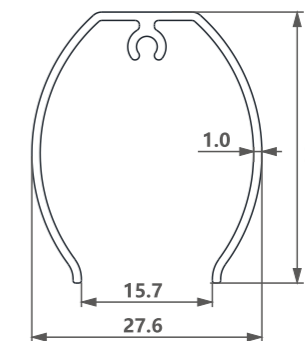

型号/Item No.-11181555
米重/Weight-0.253kg/m

柔纱帘 (斑马帘) 小圆杆

Zebra Blind Round Tube

柔纱帘 (斑马帘) 小圆杆型材及配件-11161601
Zebra Blind Round Tube With Components

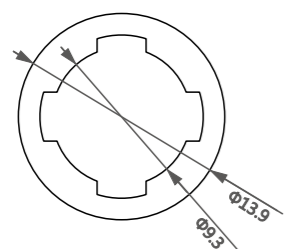

型号/Item No.-11161601
米重/Weight-0.198kg/m

▼ 封盖 End Caps



香格里拉帘下杆及配重

Shangri-la Blind Bottom Rail

香格里拉帘下杆+配重型材及配件-11162016+11162017
Shangri-la Blind Bottom Rail Profile With Components

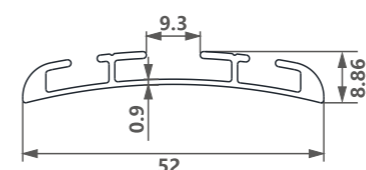

型号/Item No.-11162016
米重/Weight-0.317kg/m

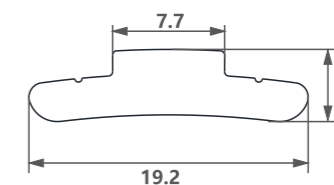

型号/Item No.-11162017
米重/Weight-0.176kg/m

▼ 封盖 End Caps



柔纱帘/斑马帘&香格里拉帘型材

Zebra Blind Bottom Rail Profile

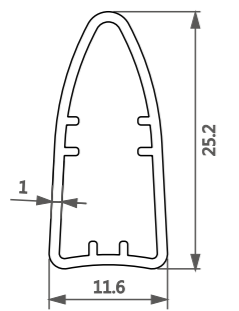

型号/Item No.-1116077
米重/Weight-0.183kg/m

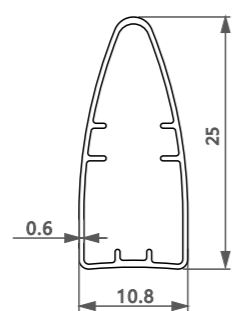

型号/Item No.-11161040
米重/Weight-0.113kg/m

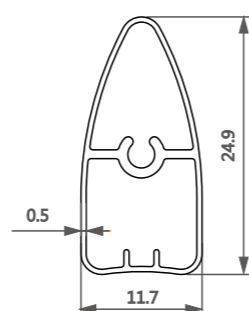

型号/Item No.-11161429
米重/Weight-0.126kg/m

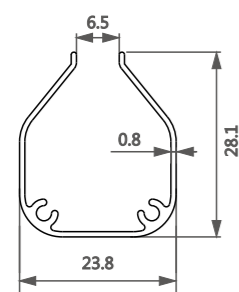

型号/Item No.-11181361
米重/Weight-0.214kg/m

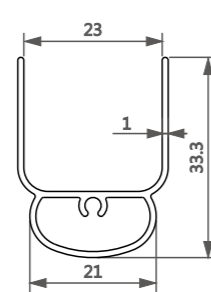

型号/Item No.-1118942
米重/Weight-0.290kg/m

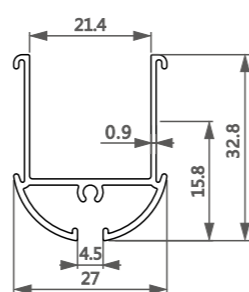

型号/Item No.-1116540
米重/Weight-0.318kg/m

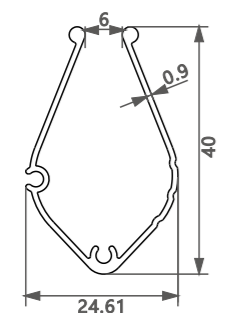

型号/Item No.-11182093
米重/Weight-0.275kg/m

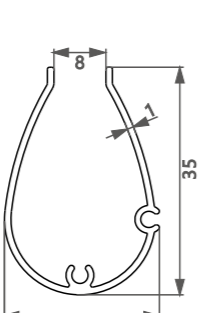

型号/Item No.-11182097
米重/Weight-0.26kg/m

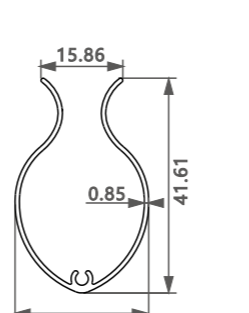

型号/Item No.-11182115
米重/Weight-0.253kg/m

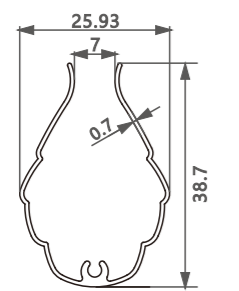

型号/Item No.-11181162
米重/Weight-0.212kg/m

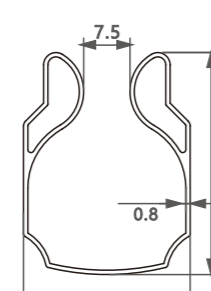

型号/Item No.-11161329
米重/Weight-0.277kg/m

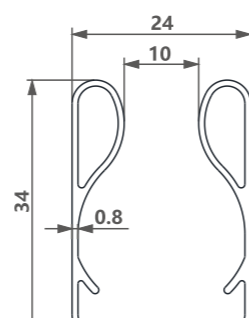

型号/Item No.-11162199
米重/Weight-0.326kg/m

柔纱帘/斑马帘&香格里拉帘型材

Zebra Blind Bottom Rail Profile

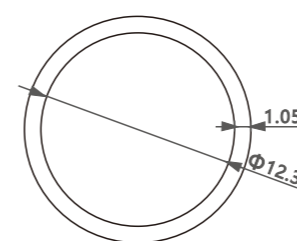

型号/Item No.-6110276
米重/Weight-0.120kg/m

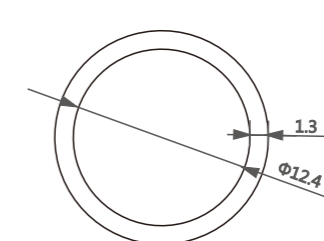

型号/Item No.-611095
米重/Weight-0.153kg/m

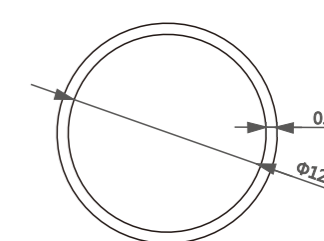

型号/Item No.-6110580
米重/Weight-0.079kg/m

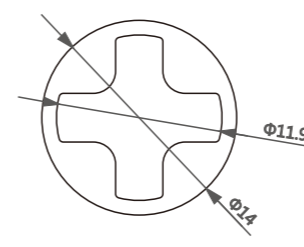

型号/Item No.-1116078
米重/Weight-0.226kg/m

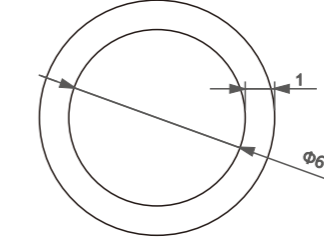

型号/Item No.-6110172
米重/Weight-0.060kg/m

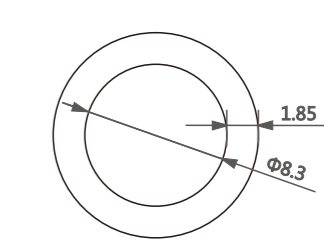

型号/Item No.-6110446
米重/Weight-0.16kg/m

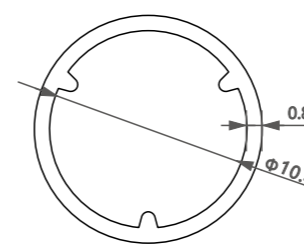

型号/Item No.-11181048
米重/Weight-0.082kg/m

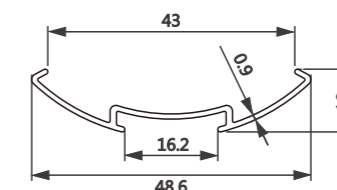

型号/Item No.-11161362
米重/Weight-0.17kg/m

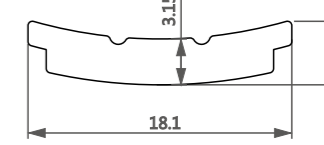

型号/Item No.-11161363
米重/Weight-0.144kg/m

03

Venetian Blind

百叶帘



雅木第一代百叶帘上轨型材及配件-1202475

Venetian Top Track Profile With Components

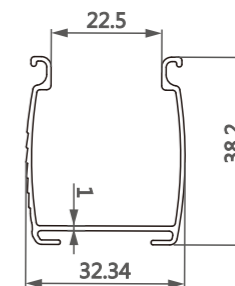

型号/Item No.-1202475
米重/Weight-0.328kg/m

▼ 封盖 End Caps



雅木第二代百叶帘上轨型材及配件-1202446

Venetian Top Track Profile With Components

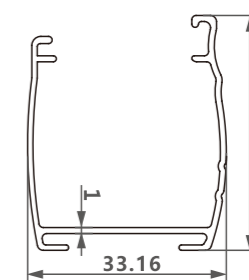

型号/Item No.-1202446
米重/Weight-0.332kg/m

▼ 封盖 End Caps



雅木第三代百叶帘上轨型材及配件-1202486

Venetian Top Track Profile With Components

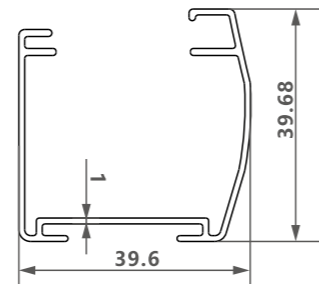

型号/Item No.-1202486
米重/Weight-0.416kg/m

▼ 封盖 End Caps



2.5百叶帘下轨型材及配件-11161185

Venetian Bottom Rail Profile With Components

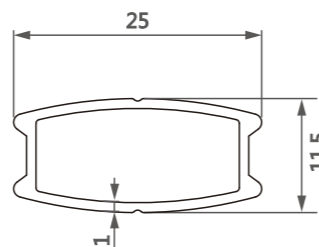
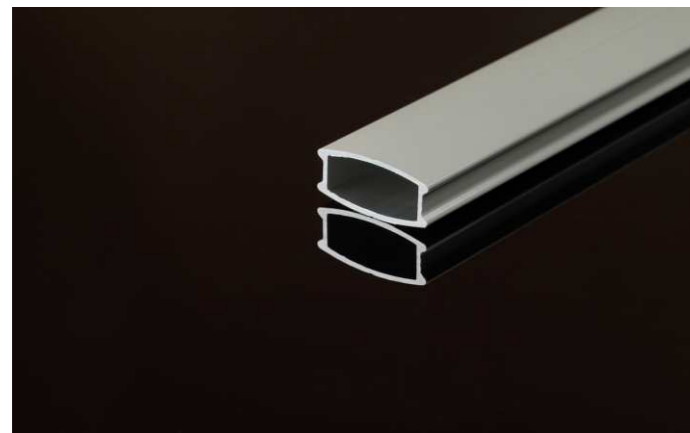

型号/Item No.-11161185
米重/Weight-0.182kg/m

▼ 封盖 End Caps



3.5百叶帘下轨型材及配件-11161349

Venetian Bottom Rail Profile With Components

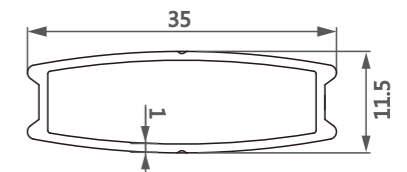

型号/Item No.-11161349
米重/Weight-0.237kg/m

▼ 封盖 End Caps



木百叶上轨型材-13031331

Venetian Top Track Profile

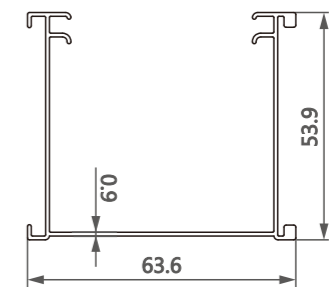

型号/Item No.-13031331
米重/Weight-0.544kg/m

木百叶下轨型材-13031330

Venetian Bottom Rail Profile

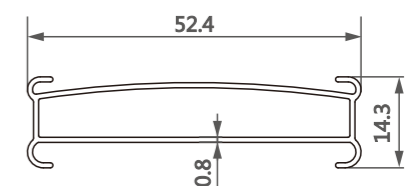
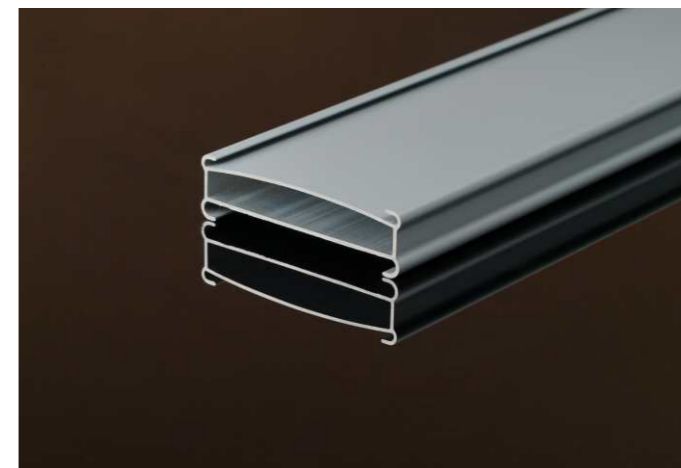

型号/Item No.-13031330
米重/Weight-0.301kg/m

04

Honeycomb Blind

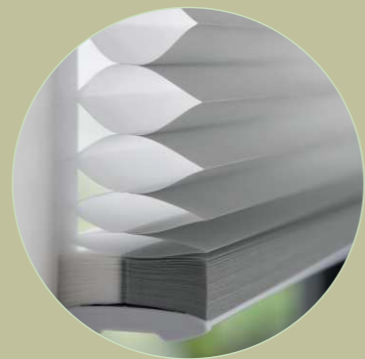

蜂巢帘



2.5蜂巢下轨型材-1514751

2.5 Honeycomb Blind Bottom Track Profile With Components

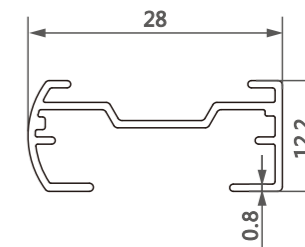

型号/Item No.-1514751
米重/Weight-0.163kg/m

▼ 端盖 End Caps



手动蜂巢帘四合一边轨型材-19071282

Honeycomb Blind Profile

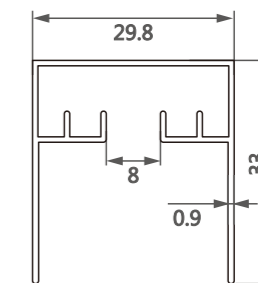

型号/Item No.-19071282
米重/Weight-0.293kg/m

蜂巢帘
Honeycomb Blind

手动蜂巢帘隐型移轨型材-1514898
Honeycomb Blind Profile

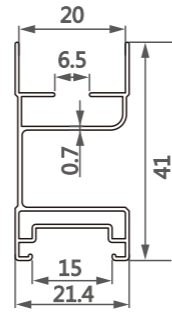

型号/Item No.-1514898
米重/Weight-0.288kg/m

电动蜂巢帘边轨（侧轨）-13031052
Honeycomb Blind Profile

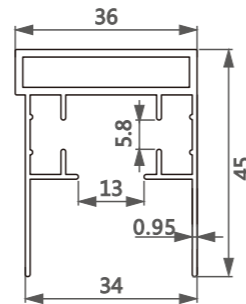
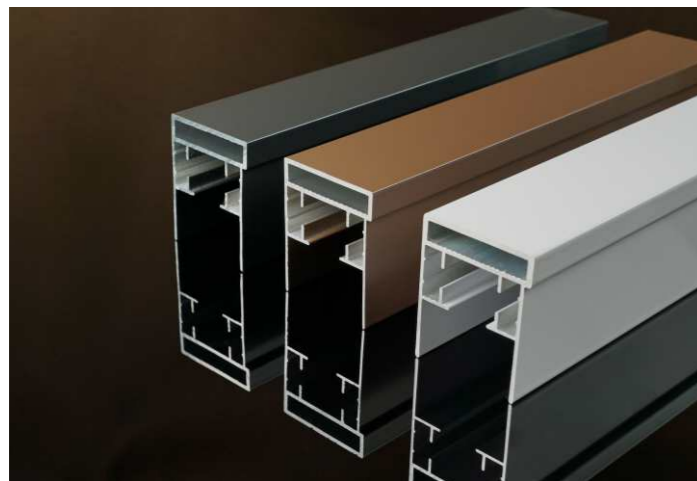

型号/Item No.-13031052
米重/Weight-0.634kg/m

内开窗蜂巢帘型材-13031404
Honeycomb Blind Profile

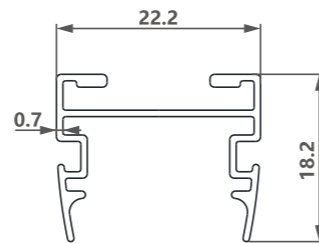

型号/Item No.-13031404
米重/Weight-0.174kg/m

电动蜂巢帘上下轨及盖板-19071463+19071485
Honeycomb Blind Profile

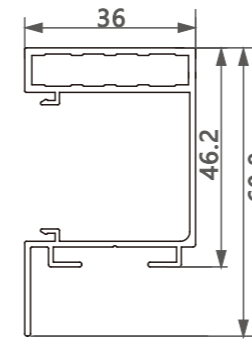
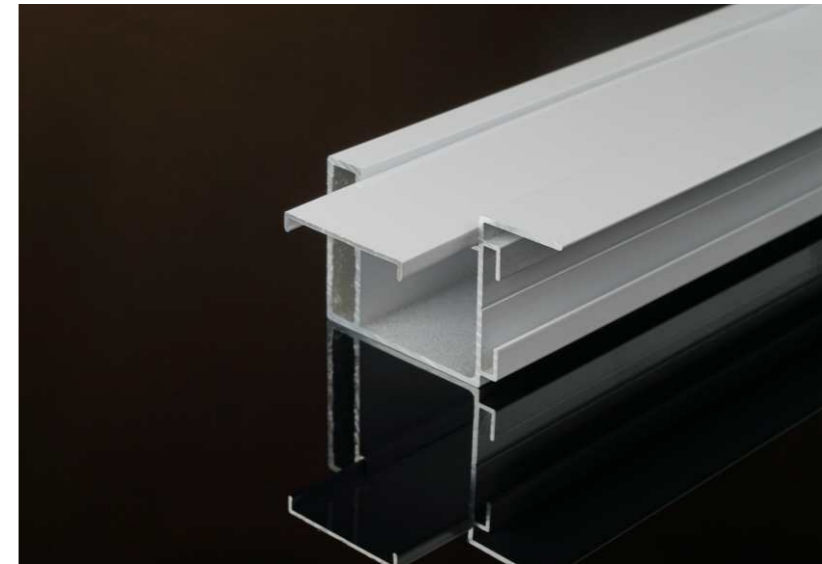

型号/Item No.-19071463
米重/Weight-0.699kg/m

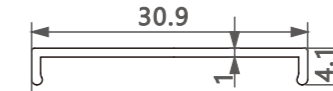

型号/Item No.-19071485
米重/Weight-0.101kg/m

电动蜂巢帘移轨-13031380
Honeycomb Blind Profile

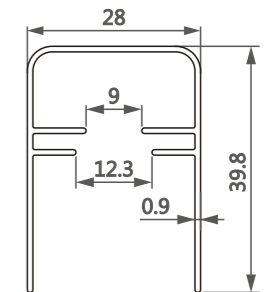

型号/Item No.-13031380
米重/Weight-0.328kg/m

百叶帘&蜂巢帘型材
Venetian Blind & Honeycomb Blind Profile

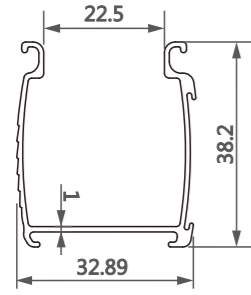

型号/Item No.-1202480
米重/Weight-0.349kg/m

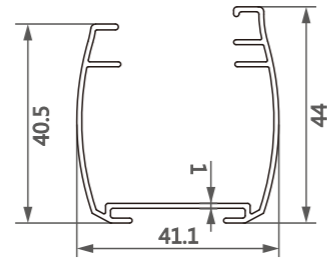

型号/Item No.-13031110
米重/Weight-0.438kg/m

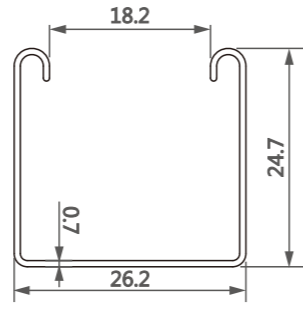

型号/Item No.-120268
米重/Weight-0.158kg/m

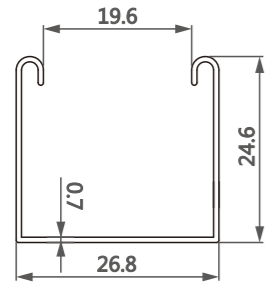

型号/Item No.-1202285
米重/Weight-0.160kg/m

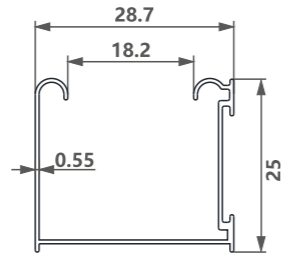

型号/Item No.-11161551
米重/Weight-0.149kg/m

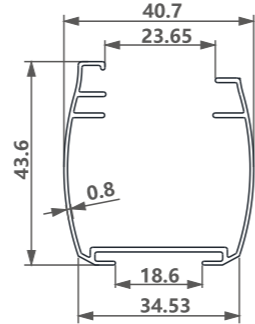

型号/Item No.-13031110-0.8
米重/Weight-0.378kg/m

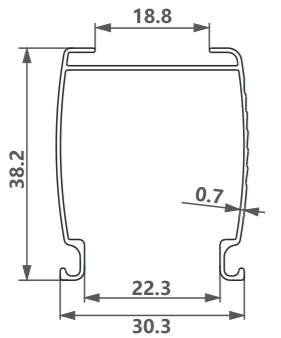

型号/Item No.-1116961-0.7
米重/Weight-0.244kg/m

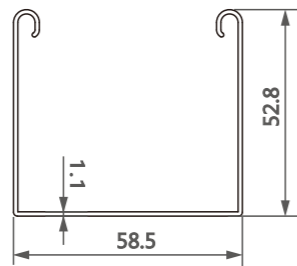

型号/Item No.-120211
米重/Weight-0.537kg/m

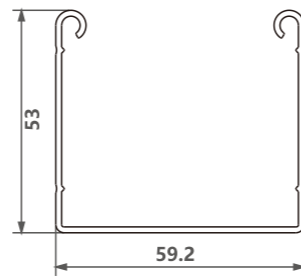

型号/Item No.-120201
米重/Weight-0.680kg/m

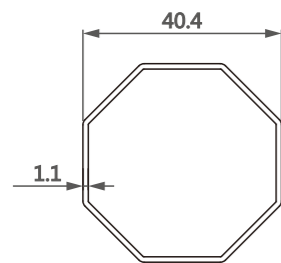

型号/Item No.-191012
米重/Weight-0.387kg/m

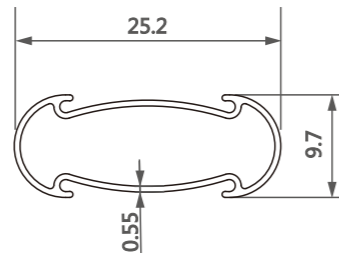

型号/Item No.-11161550
米重/Weight-0.106kg/m

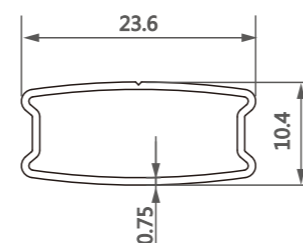

型号/Item No.-1116474
米重/Weight-0.128kg/m

百叶帘&蜂巢帘型材
Venetian Blind & Honeycomb Blind Profile

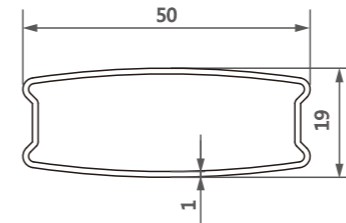

型号/Item No.-11161547
米重/Weight-0.348kg/m

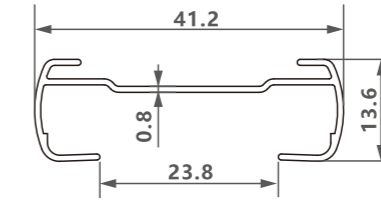

型号/Item No.-1514714
米重/Weight-0.193kg/m

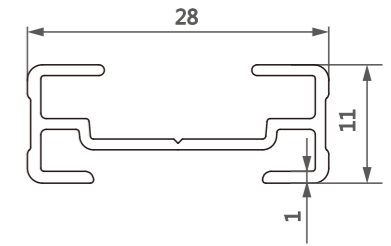

型号/Item No.-1514606
米重/Weight-0.201kg/m

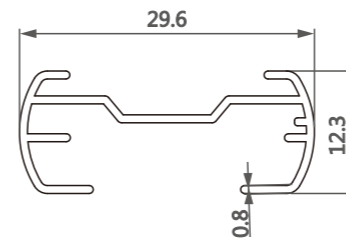

型号/Item No.-1514681
米重/Weight-0.165kg/m

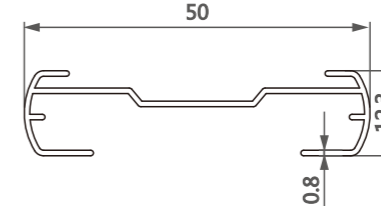

型号/Item No.-1514682
米重/Weight-0.245kg/m

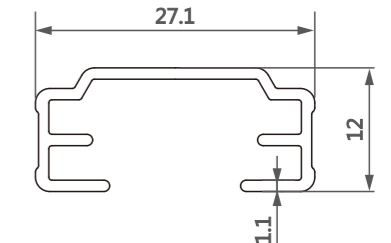

型号/Item No.-1514239
米重/Weight-0.197kg/m

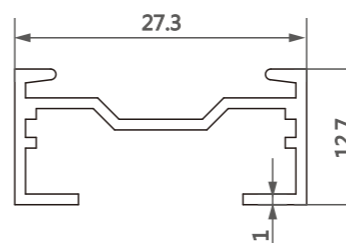

型号/Item No.-1514112
米重/Weight-0.198kg/m

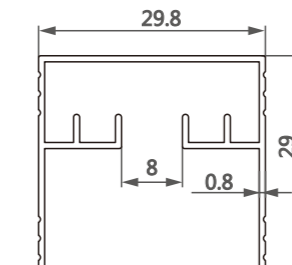

型号/Item No.-79081085
米重/Weight-0.259kg/m

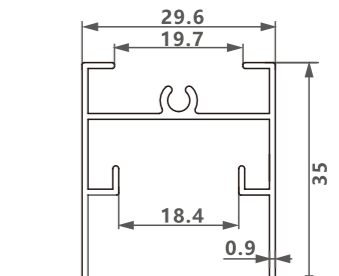

型号/Item No.-1303755-0.9
米重/Weight-0.331kg/m

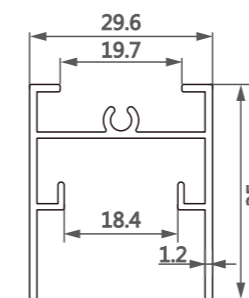

型号/Item No.-1303755
米重/Weight-0.399kg/m

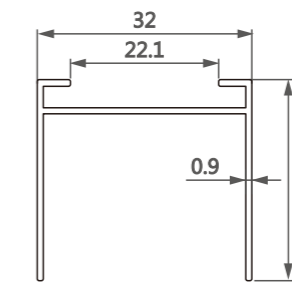

型号/Item No.-1303757
米重/Weight-0.243kg/m

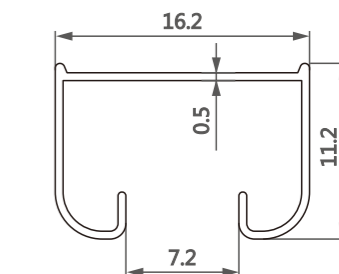

型号/Item No.-1303758
米重/Weight-0.065kg/m

百叶帘&蜂巢帘型材
Venetian Blind & Honeycomb Blind Profile

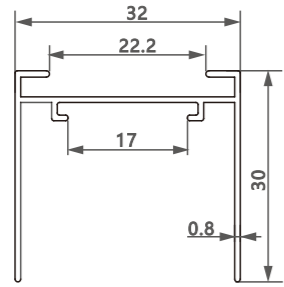

型号/Item No.-13031581
米重/Weight-0.234kg/m

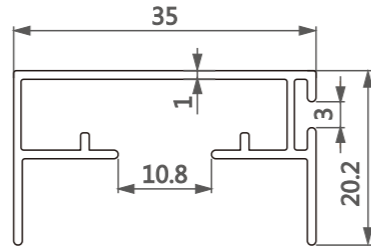

型号/Item No.-13031048
米重/Weight-0.278kg/m

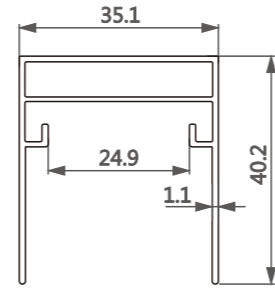

型号/Item No.-13031049
米重/Weight-0.433kg/m

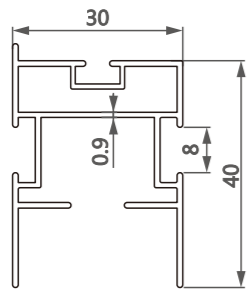

型号/Item No.-13031050
米重/Weight-0.484kg/m

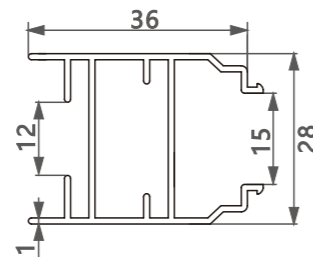

型号/Item No.-13031242
米重/Weight-0.435kg/m

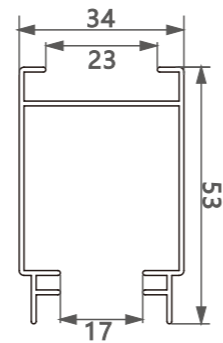

型号/Item No.-13031243
米重/Weight-0.465kg/m

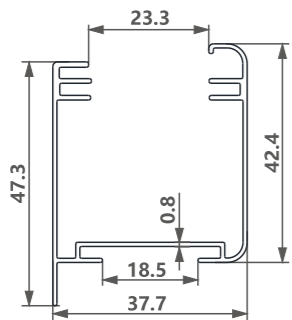

型号/Item No.-1202680-0.8
米重/Weight-0.409kg/m

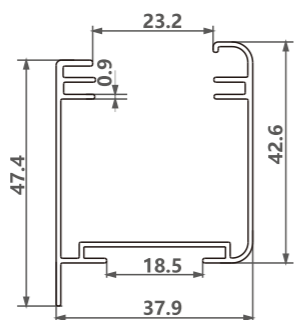

型号/Item No.-1202680
米重/Weight-0.452kg/m

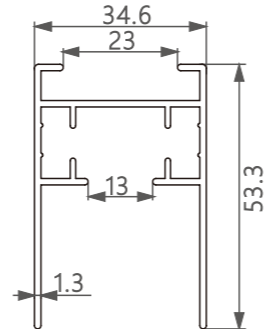

型号/Item No.-13031246
米重/Weight-0.639kg/m

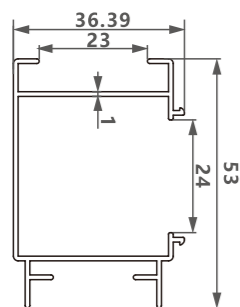

型号/Item No.-13031244
米重/Weight-0.461kg/m

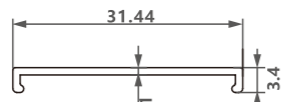

型号/Item No.-13031245
米重/Weight-0.101kg/m

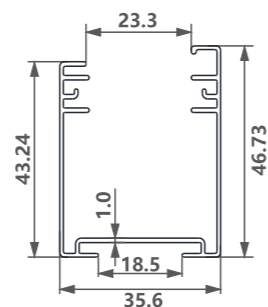

型号/Item No.-1202719
米重/Weight-0.426kg/m

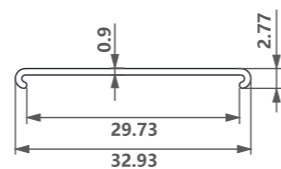

型号/Item No.-1202720
米重/Weight-0.089kg/m

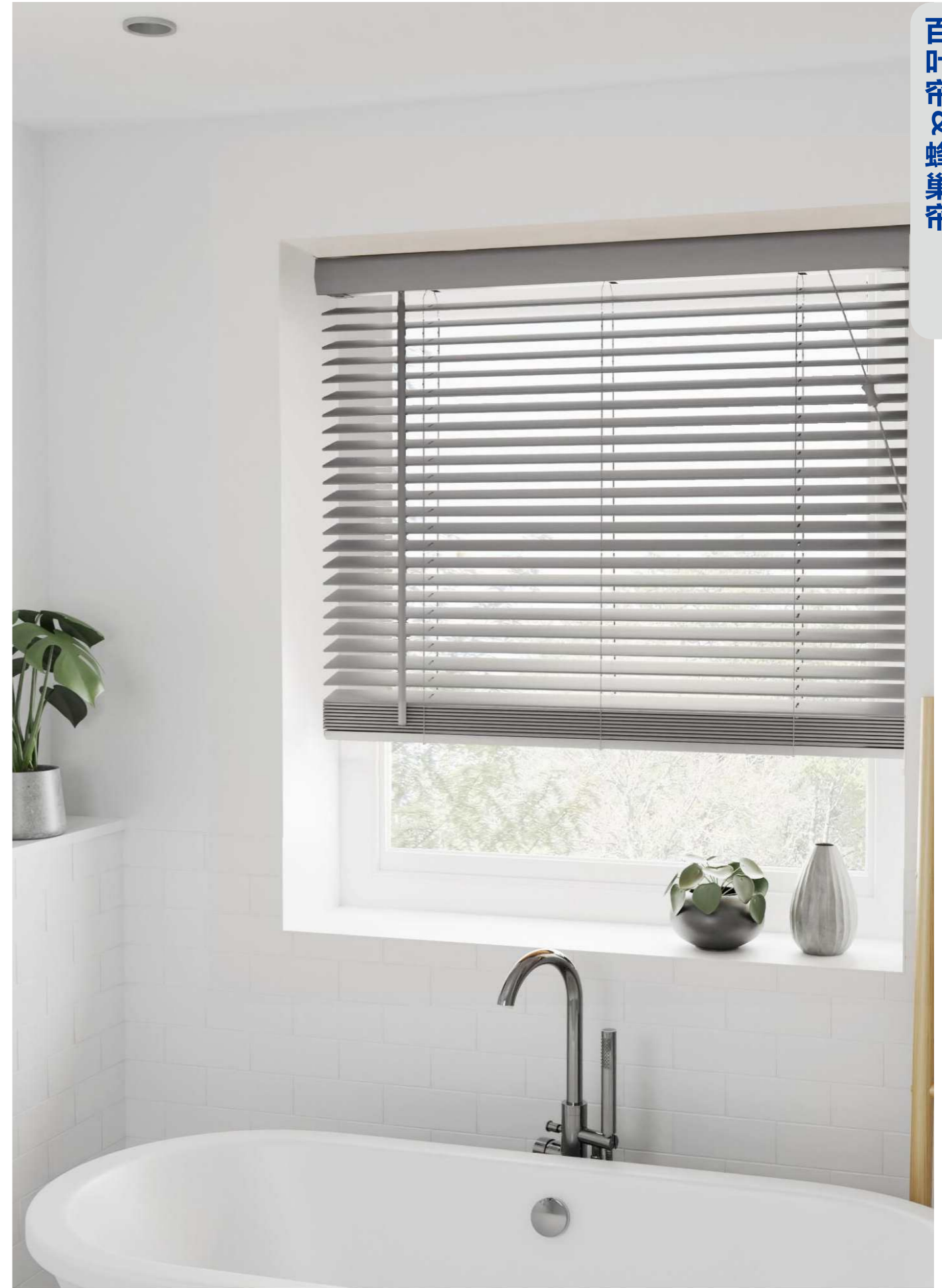

05

Vertical Blind

垂直帘



乐屋电动梦幻帘型材-13031776

Vertical Blind Profile

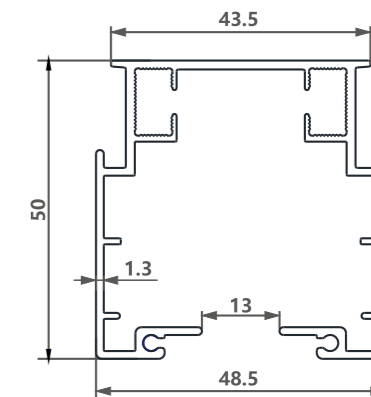

型号/Item No.-13031776
米重/Weight-0.868kg/m

垂直帘
Vertical Blind

手动梦幻帘上轨型材-13031453

Vertical Blind Profile

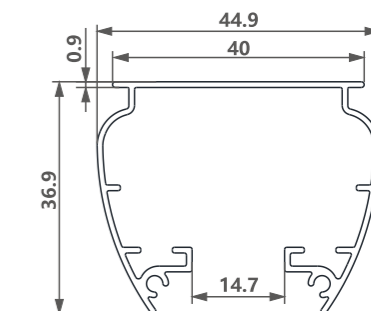

型号/Item No.-13031453
米重/Weight-0.425kg/m

垂直帘上轨型材-130325

Vertical Blind Profile



0.8mm壁厚

Thickness: 0.8mm

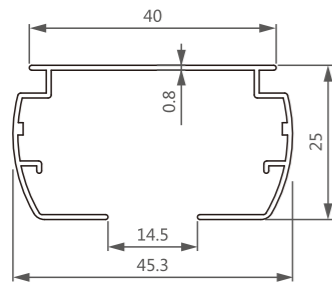

型号/Item No.-130325
米重/Weight-0.288kg/m

1.0mm壁厚

Thickness: 1.0mm

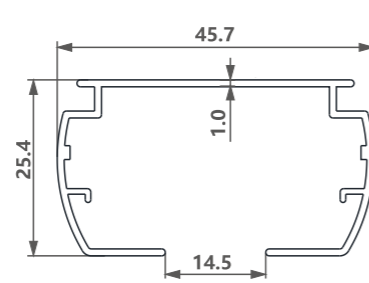

型号/Item No.-130325-1.0
米重/Weight-0.357kg/m

穿布条-C轨型材-1118965

Vertical Blind Profile

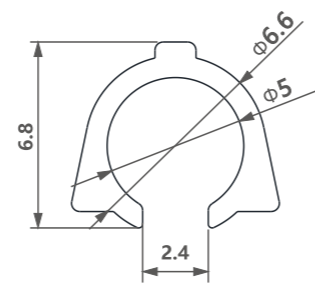

型号/Item No.-1118965
米重/Weight-0.045kg/m

垂直帘型材

Vertical Blind Profile

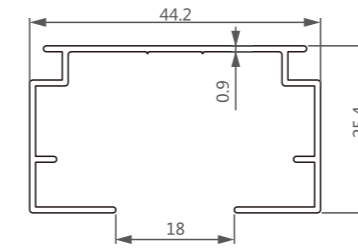

型号/Item No.-130345
米重/Weight-0.317kg/m

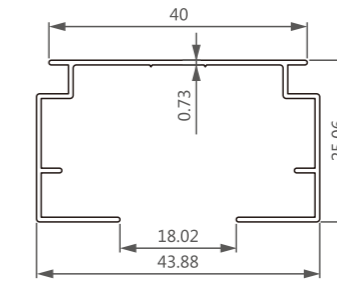

型号/Item No.-1303271
米重/Weight-0.257kg/m

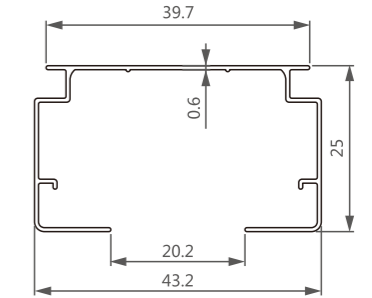

型号/Item No.-1303659
米重/Weight-0.208kg/m

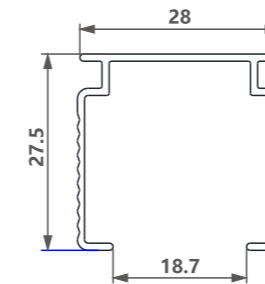

型号/Item No.-1303835
米重/Weight-0.241kg/m

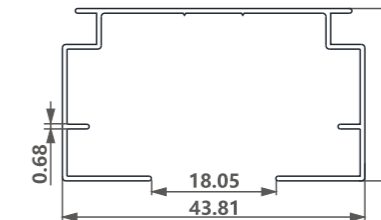

型号/Item No.-130345-0.68
米重/Weight-0.238kg/m

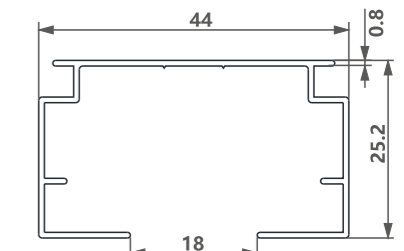

型号/Item No.-130345-0.8
米重/Weight-0.281kg/m

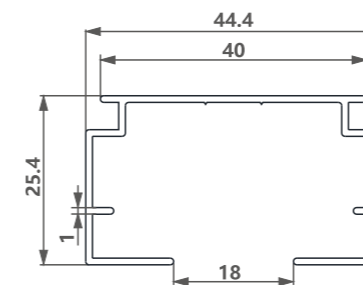

型号/Item No.-130345-1.0
米重/Weight-0.352kg/m

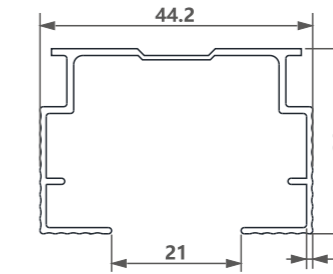

型号/Item No.-130303
米重/Weight-0.36kg/m

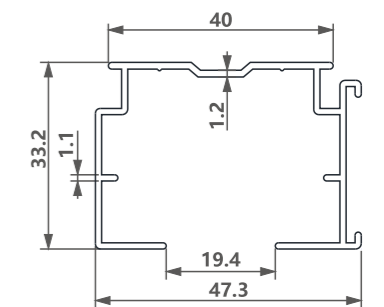

型号/Item No.-1303213
米重/Weight-0.478kg/m

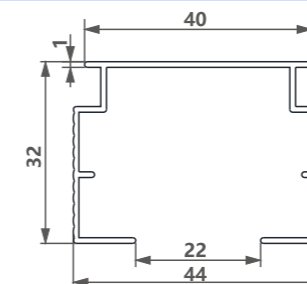

型号/Item No.-150570
米重/Weight-0.361kg/m

06

Roman Blind

罗马帘



罗马帘型材 Roman Blind Profile

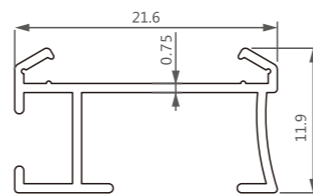

型号/Item No.-110173
米重/Weight-0.121kg/m

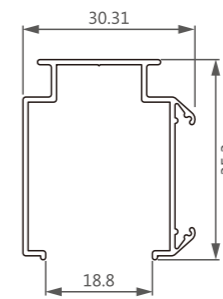

型号/Item No.-1116056
米重/Weight-0.284kg/m

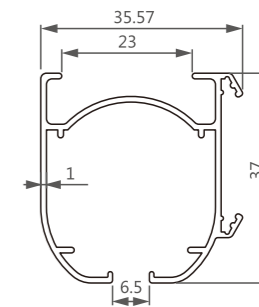

型号/Item No.-1116055
米重/Weight-0.409kg/m

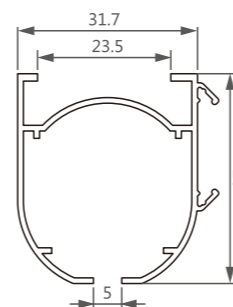

型号/Item No.-1118511
米重/Weight-0.392kg/m

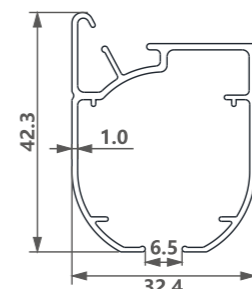

型号/Item No.-11181619
米重/Weight-0.427kg/m

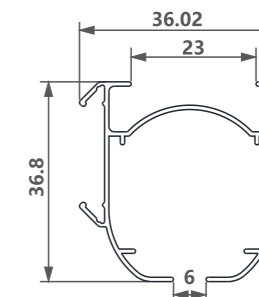

型号/Item No.-111367
米重/Weight-0.327kg/m

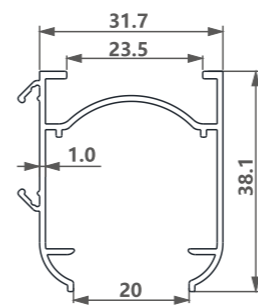

型号/Item No.-1118512
米重/Weight-0.385kg/m

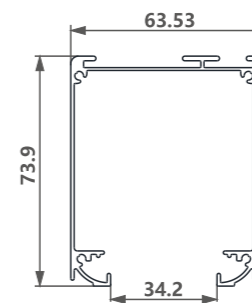

型号/Item No.-13031296
米重/Weight-0.966kg/m

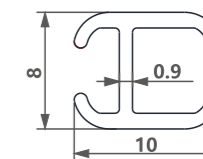

型号/Item No.-1514874
米重/Weight-0.076kg/m

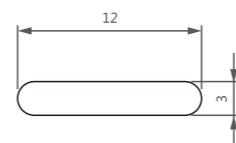

型号/Item No.-920011
米重/Weight-0.093kg/m

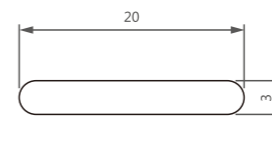

型号/Item No.-920046
米重/Weight-0.159kg/m

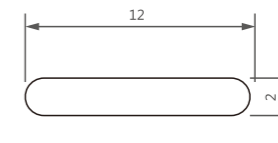

型号/Item No.-920010
米重/Weight-0.063kg/m

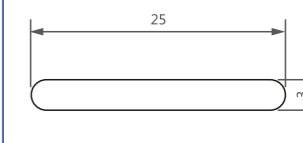

型号/Item No.-920021
米重/Weight-0.199kg/m

罗马帘
Roman Blind

07

Tilt Rod

铝芯



铝芯-13031775
Tilt Rod

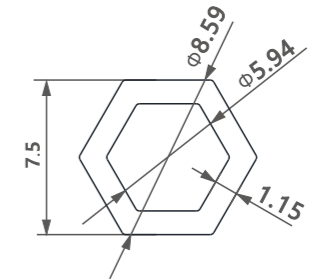
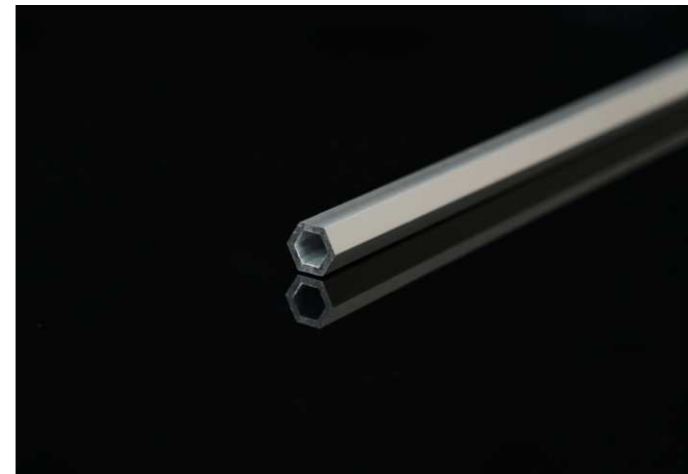

型号/Item No.-13031775
米重/Weight-0.069kg/m

铝芯-130312
Tilt Rod

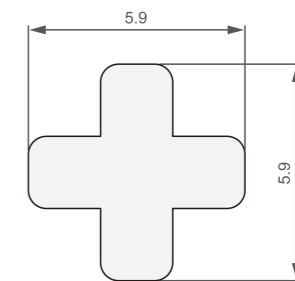

型号/Item No.-130312
米重/Weight-0.053kg/m

铝芯-130313
Tilt Rod

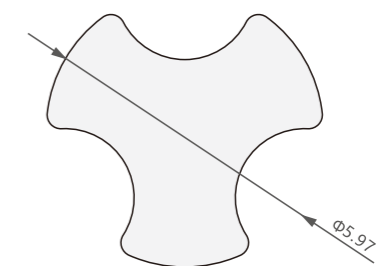

型号/Item No.-130313
米重/Weight-0.050kg/m

铝芯
Tilt Rod

铝芯-191137

Tilt Rod

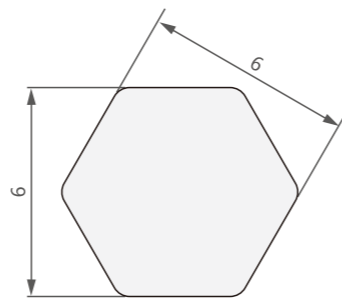

型号/Item No.-191137
米重/Weight-0.085kg/m

铝芯型材

Tilt Rod Profile

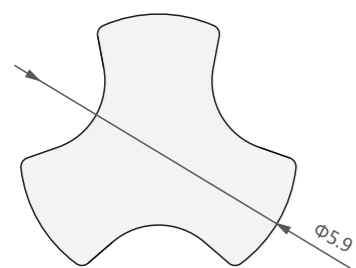

型号/Item No.-1303169
米重/Weight-0.050kg/m

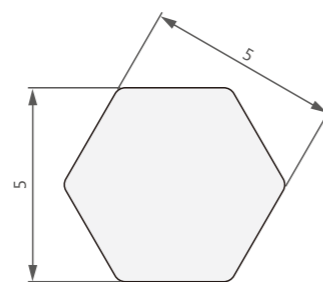

型号/Item No.-111317
米重/Weight-0.059kg/m

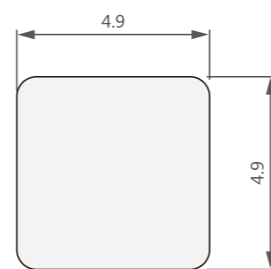

型号/Item No.-151401
米重/Weight-0.065kg/m

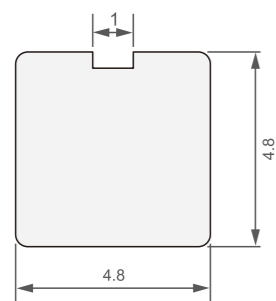

型号/Item No.-1303209
米重/Weight-0.062kg/m

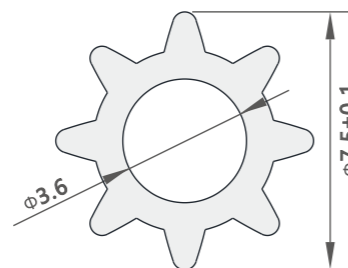

型号/Item No.-1303356
米重/Weight-0.053kg/m



08

Curtain Track

轨道



1.6mm开合帘尚飞轨型材-13031150
1.6mm Electric Curtain Track Profile

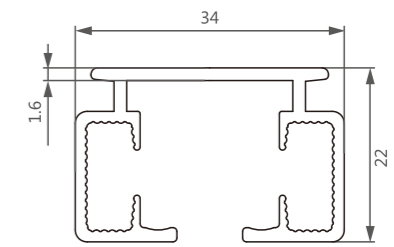
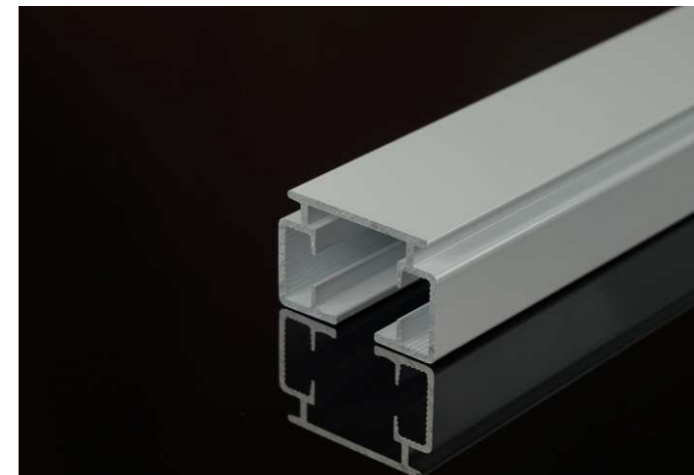

型号/Item No.-13031150
米重/Weight-0.473 kg/m

1.8mm开合帘尚飞轨型材-13031001
1.8mm Electric Curtain Track Profile

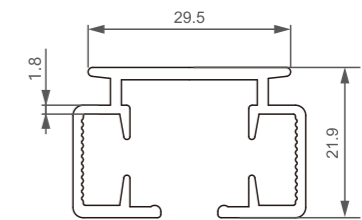

型号/Item No.-13031001
米重/Weight-0.496kg/m

2.2mm开合帘尚飞轨型材-1303442
2.2mm Electric Curtain Track Profile

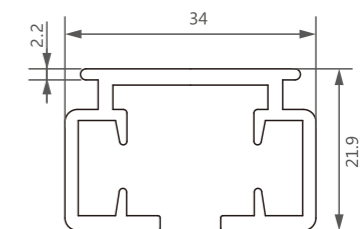

型号/Item No.-1303442
米重/Weight-0.579 kg/m

轨道
Curtain Track

轨道型材
Curtain Track Profile

轨道型材
Curtain Track Profile

轨道
Curtain Track

轨道
Curtain Track

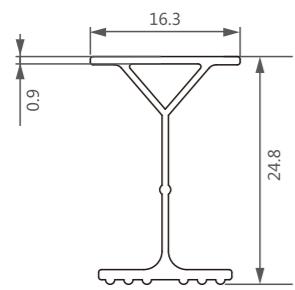

型号/Item No.-1404137
米重/Weight-0.152kg/m

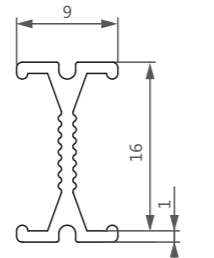

型号/Item No.-1404128
米重/Weight-0.109kg/m

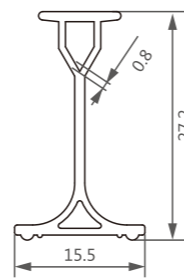

型号/Item No.-1404121
米重/Weight-0.179kg/m

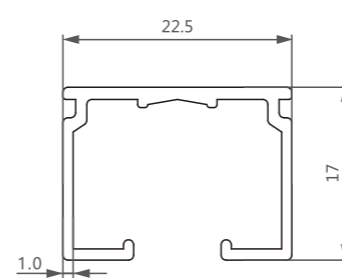

型号/Item No.-13031425
米重/Weight-0.215kg/m

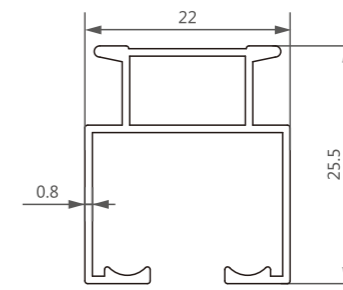

型号/Item No.-1303898
米重/Weight-0.244kg/m

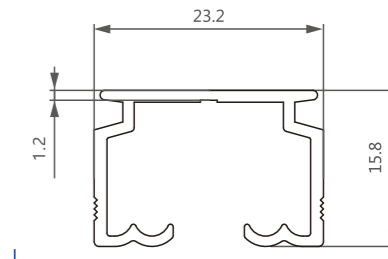

型号/Item No.-13031323
米重/Weight-0.226kg/m

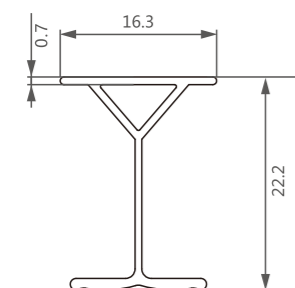

型号/Item No.-140491
米重/Weight-0.130kg/m

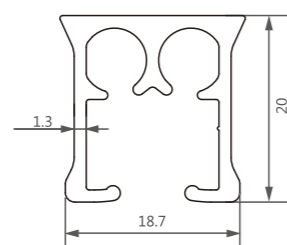

型号/Item No.-1303523
米重/Weight-0.329kg/m

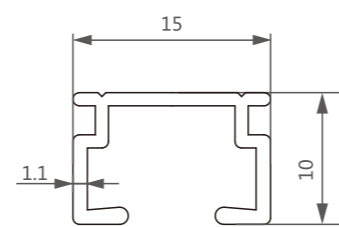

型号/Item No.-1303201
米重/Weight-0.120kg/m

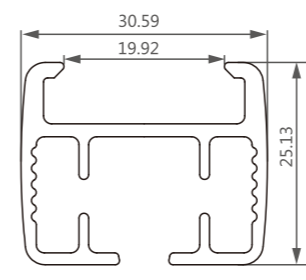

型号/Item No.-1303633
米重/Weight-0.530kg/m

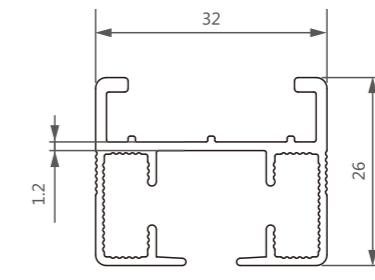

型号/Item No.-1514575
米重/Weight-0.444kg/m

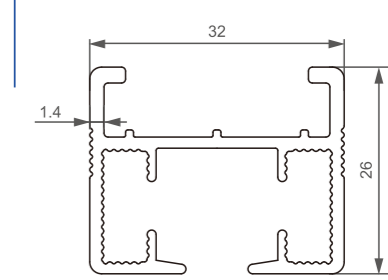

型号/Item No.-1303901
米重/Weight-0.51kg/m

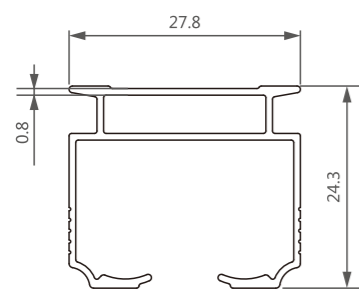

型号/Item No.-1514770
米重/Weight-0.271kg/m

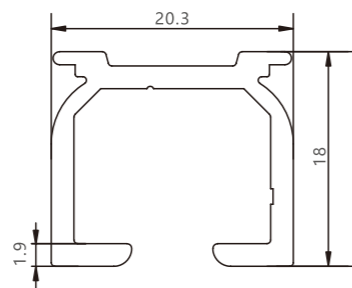

型号/Item No.-1514948
米重/Weight-0.307kg/m

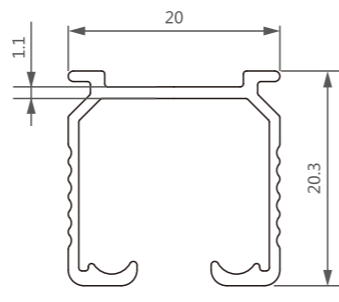

型号/Item No.-1303844
米重/Weight-0.204kg/m

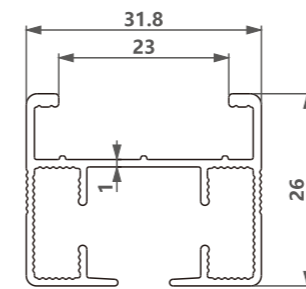

型号/Item No.-15141130
米重/Weight-0.373kg/m

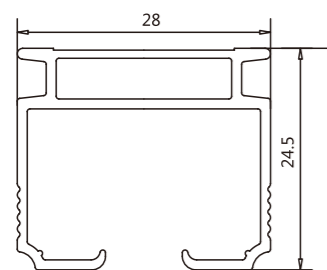

型号/Item No.-1514732
米重/Weight-0.342kg/m

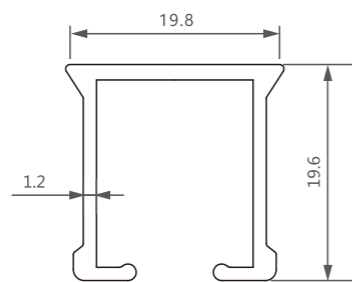

型号/Item No.-1514154
米重/Weight-0.235kg/m

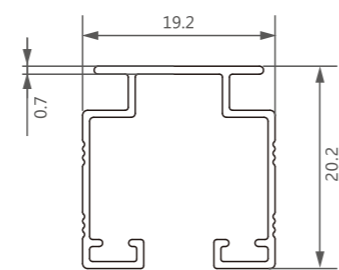

型号/Item No.-13031308
米重/Weight-0.162kg/m

09

Panel Track

屏风帘系列



屏风帘型材 Panel Track Profile

Panel Track
屏风帘系列

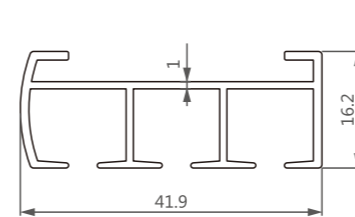

型号/Item No.-151471
米重/Weight-0.355kg/m

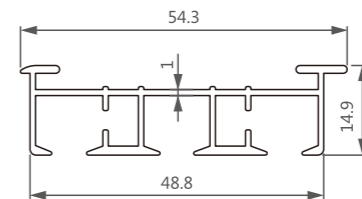

型号/Item No.-1514956
米重/Weight-0.415kg/m

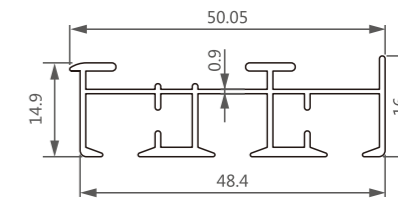

型号/Item No.-1514178
米重/Weight-0.388kg/m

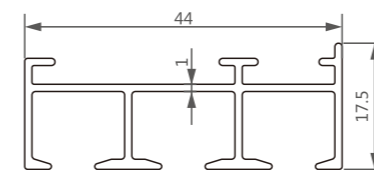

型号/Item No.-1514859
米重/Weight-0.370kg/m

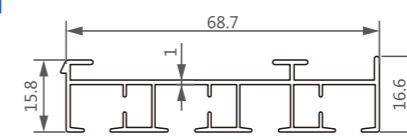

型号/Item No.-1514832
米重/Weight-0.508kg/m

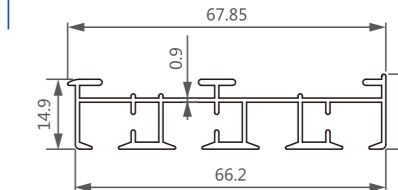

型号/Item No.-1514180
米重/Weight-0.548kg/m

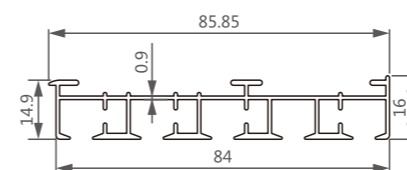

型号/Item No.-1514179
米重/Weight-0.672kg/m

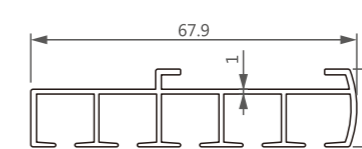

型号/Item No.-151472
米重/Weight-0.522kg/m

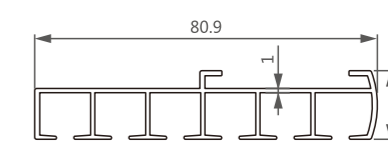

型号/Item No.-151477
米重/Weight-0.605kg/m

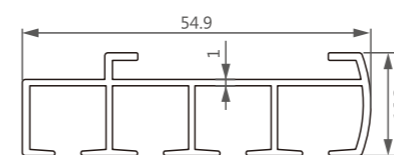

型号/Item No.-151478
米重/Weight-0.438kg/m

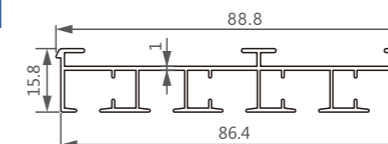

型号/Item No.-1514833
米重/Weight-0.617kg/m

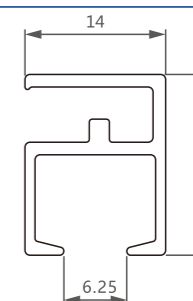

型号/Item No.-1514858
米重/Weight-0.198kg/m

屏风帘型材
Panel Track Profile

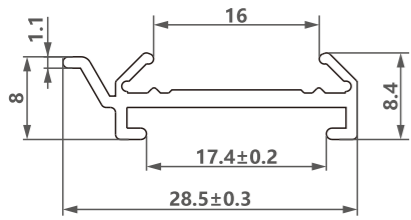

型号/Item No.-151461
米重/Weight-0.176kg/m

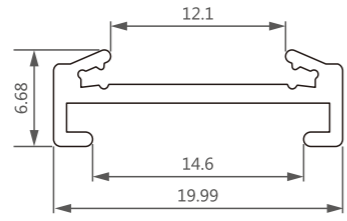

型号/Item No.-11181288
米重/Weight-0.118kg/m

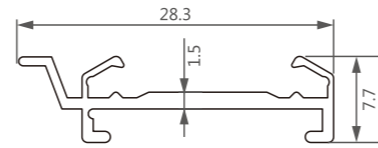

型号/Item No.-1514136
米重/Weight-0.139kg/m

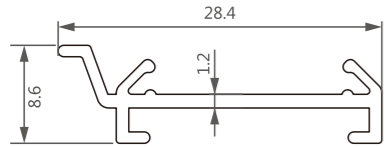

型号/Item No.-13031030
米重/Weight-0.148kg/m

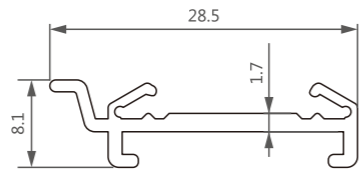

型号/Item No.-151492
米重/Weight-0.175kg/m



10

Side Track

边槽



边槽型材-4278330

Side Track Profile

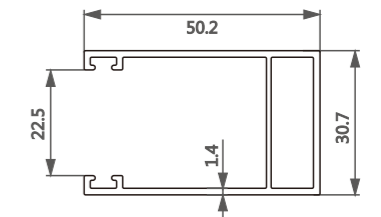

型号/Item No.-4278330
米重/Weight-0.615kg/m

边槽型材-79081040

Side Track Profile

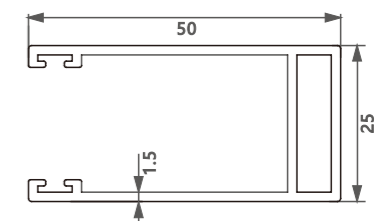

型号/Item No.-79081040
米重/Weight-0.635kg/m

边槽
Side Track

边槽型材-0901592

Side Track Profile

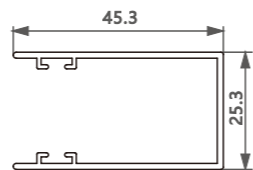

型号/Item No.-0901592
米重/Weight-0.438kg/m

边槽型材-79081139

Side Track Profile

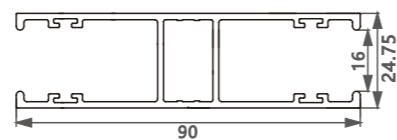
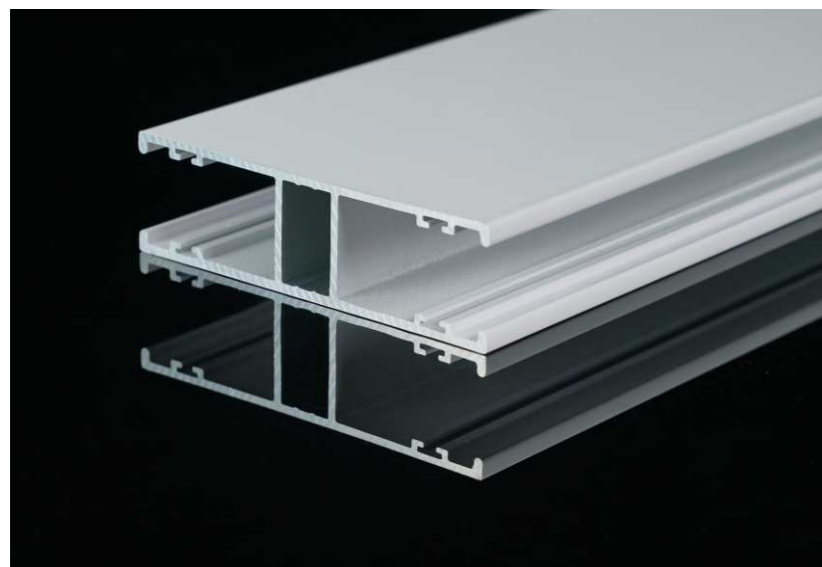

型号/Item No.-79081139
米重/Weight-1.133kg/m

边槽型材

Side Track Profile

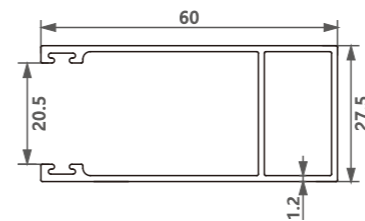

型号/Item No.-79081015-1.2
米重/Weight-0.62kg/m

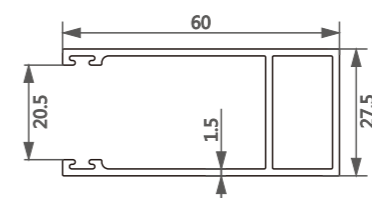

型号/Item No.-79081015-1.5
米重/Weight-0.74kg/m

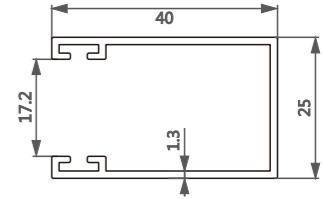

型号/Item No.-0901586
米重/Weight-0.424kg/m

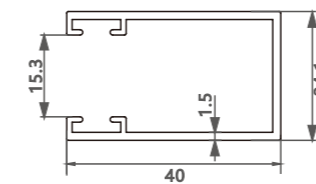

型号/Item No.-0901583
米重/Weight-0.466kg/m

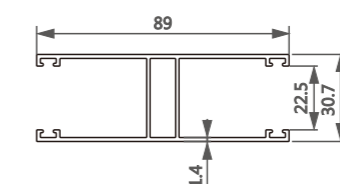

型号/Item No.-4278329
米重/Weight-0.961kg/m

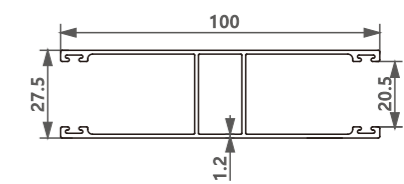

型号/Item No.-79081016-1.2
米重/Weight-0.945kg/m

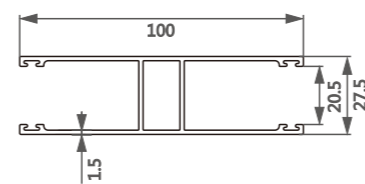

型号/Item No.-79081016-1.5
米重/Weight-1.116kg/m



本目录各项产品颜色因摄影以及印刷的缘故，与实物会有所偏差，请以实物为准。

Due to photography, printing and other reasons,
The color of each product in this catalog may deviate from the actual product, please refer to the actual product.



永丰铝型材公众号



永丰铝型材官网
yfa@yfa.tm